

# ABEL HMT/HMQ

From the reciprocating positive  
displacement pump specialist

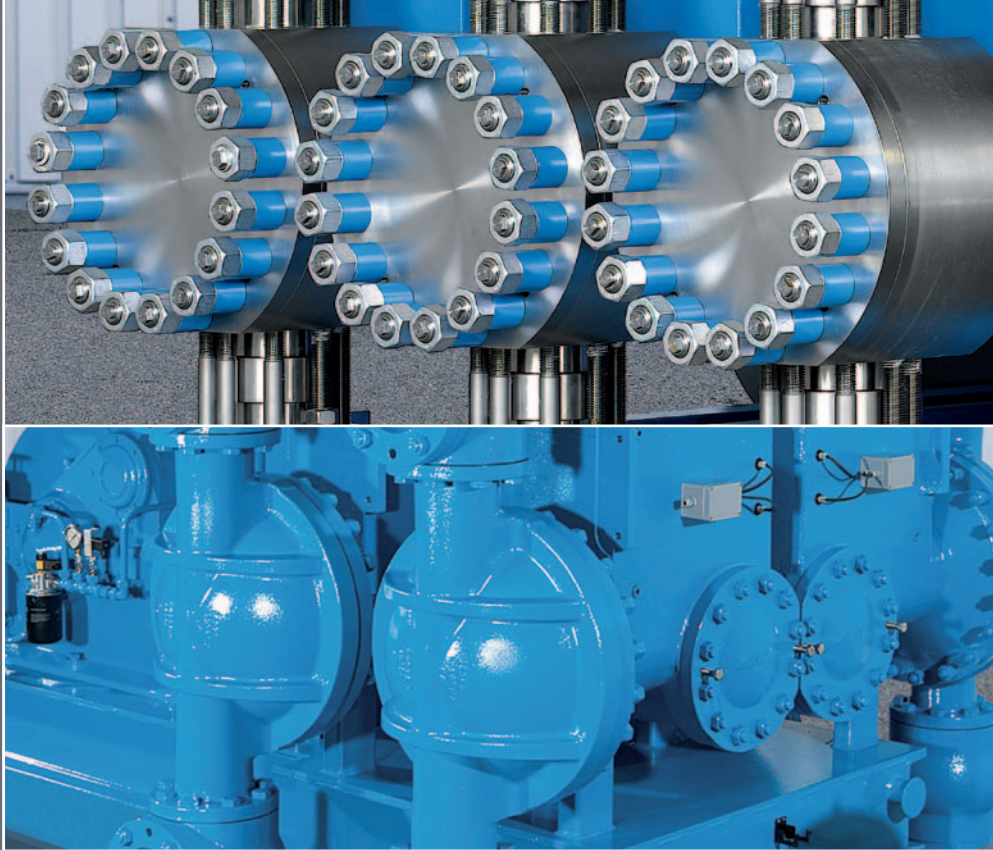

## Hydraulic Diaphragm Pumps

Pumping large volumes of  
abrasive fluids against high  
pressures

## ABEL HMT & HMQ High Performance Pumps



ABEL HMQ for tailings transfer in a copper/nickel mine

With the HMT and HMQ piston diaphragm pump series, ABEL introduces the next generation of process pumps.

As with the whole HM series, the HMT and HMQ pumps also make use of the advantages of modern diaphragm technology: Pre-formed, pressure balanced diaphragms which are adapted to the particular application and hermetically separated hydraulic and product sides.

**ABEL REVERSE VALVES** are a special feature. They are used for aqueous solutions where larger particles could quickly settle out. To keep a particle suspended in a liquid, the particle needs to be propelled at a velocity that is greater than its sedimentation velocity (critical velocity). This is not always possible on the product side of a pump as the cross-sectional area is often several times larger than the cross section of the pipe.

As a result, larger particles may settle in the pump housing or the suction-side valves, which can lead to a loss of function. This can be prevented by using spring-loaded cone valves in a reverse design, that is, by reversing the pumping direction within the pump.

This balances the effective direction of the flow and gravity vectors, avoiding the risk of sedimentation inside the pump.



If worst comes to worst - ABEL HMQ und HMT



ABEL HMT for transfer of concentrated copper tailings

### Operation

The piston and diaphragm move from the center position to rear dead center during the suction stroke. The diaphragm contacts the backside on the diaphragm housing before the piston has completed its suction stroke. The piston continues to move towards the rear dead center, creating negative pressure on the hydraulic side. Fluid travels from the hydraulic reservoir tank through the return valve and the replenishing port into the cylinder area until the

negative pressure is equalized. Now the piston performs the discharge stroke and moves from the rear dead center to the front dead center position. The diaphragm performs a discharge stroke and forces the pumping medium out of the pump housing.

If the diaphragm moves beyond its front limit of stroke, the diaphragm rod that is connected to the diaphragm opens a port that leads to the hydraulic reservoir tank. The excess fluid travels through the port back into the hydraulic reservoir tank so that the diaphragm does not move beyond its limit defined for the discharge stroke.

A full-stroke pressure relief valve on the hydraulic side of each of the pump chambers prevents the allowable pump pressure from being exceeded.

Depending on pump pressure and pumping medium, ABEL series HMT/HMQ pumps can be equipped with ball valves or cone valves. Ball valves are the best choice for low pressure applications and/or fibrous media. For high pressure applications and/or mineral slurries, spring loaded cone valves with an elastomer insert are used.

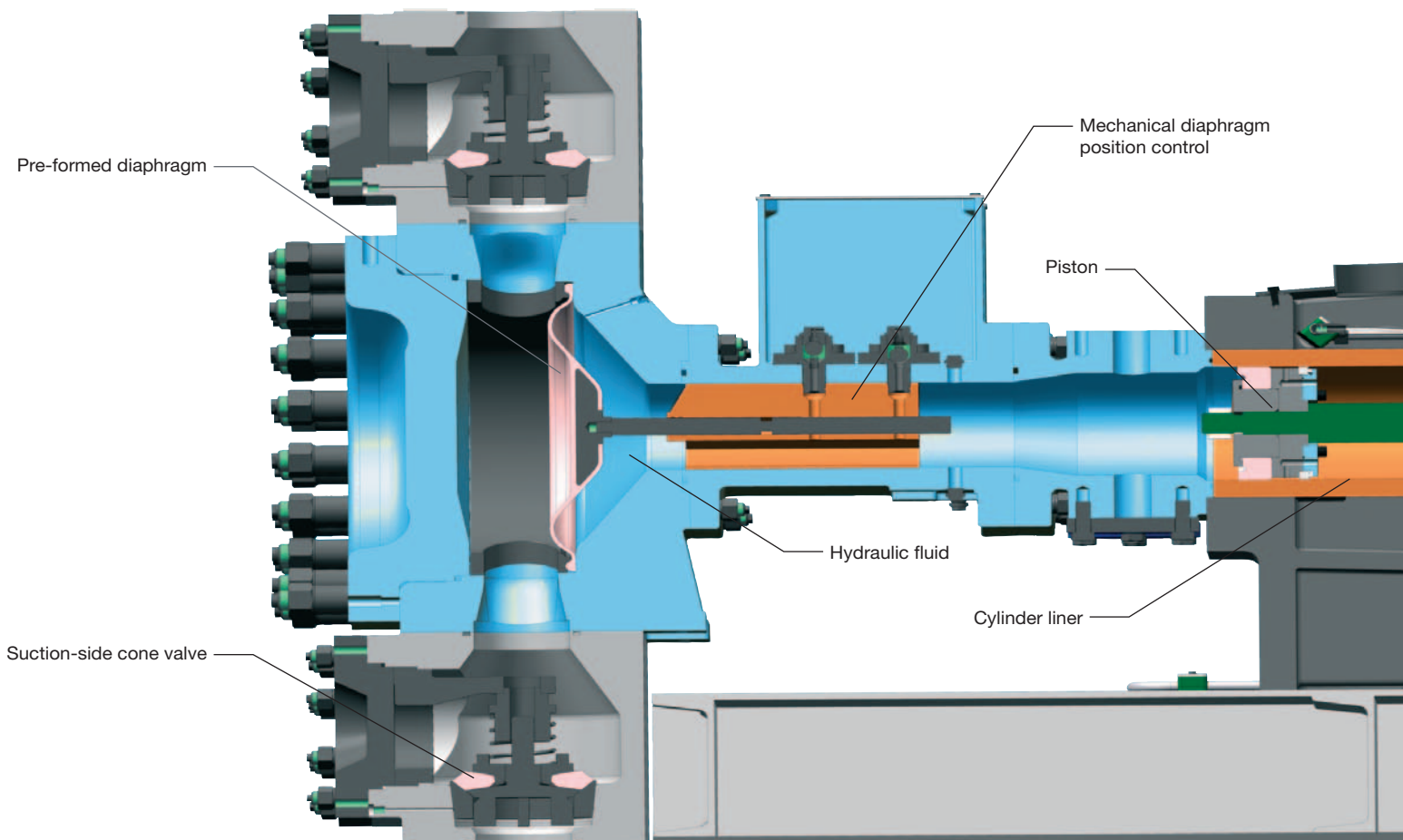

## ABEL HMT

### Hydraulic Triplex Diaphragm Pumps



Performance range: up to 240 m<sup>3</sup>/h (1056 GPM); up to 25.0 MPa (3625 psi)

**THE ABEL HMT** is a single-acting, slow-running, dry-run secure triplex piston diaphragm pump and can be used for a performance range up to 25.0 MPa (3625 psi) and pump flows up to 240 m<sup>3</sup>/h (1056 GPM).

For hydraulic solids transfer, the ABEL HMT provides a clever solution to pumping suspensions that have high dry substance content and a high specific weight. The strong points of the HMT are its quiet operation (low residual pulsation) and its ability to function at pressures above 10.0 MPa (1450 psi).

The triplex gearbox can run at high speeds because it has a crankshaft that is especially designed for this duty. The crankshaft has a crank offset of 120° which gives it a steadier volumetric flow than quadruple acting pumps. An external reduction gearbox drives the crankshaft, which is resistant to bending and is guided by two self-aligning roller bearings. The pistons are pressurized on one side.

A triplex piston pump with wear resistant cylinder linings is available by special request. The ABEL HMT makes it easy to assemble and disassemble cylinder linings and pistons.

By loosening a clamp coupling and separating the divided piston rod, you can open the cylinder lining fastener and remove the cylinder lining, pistons and the front half of the piston rod from the lantern without disassembling the product side of the pump.

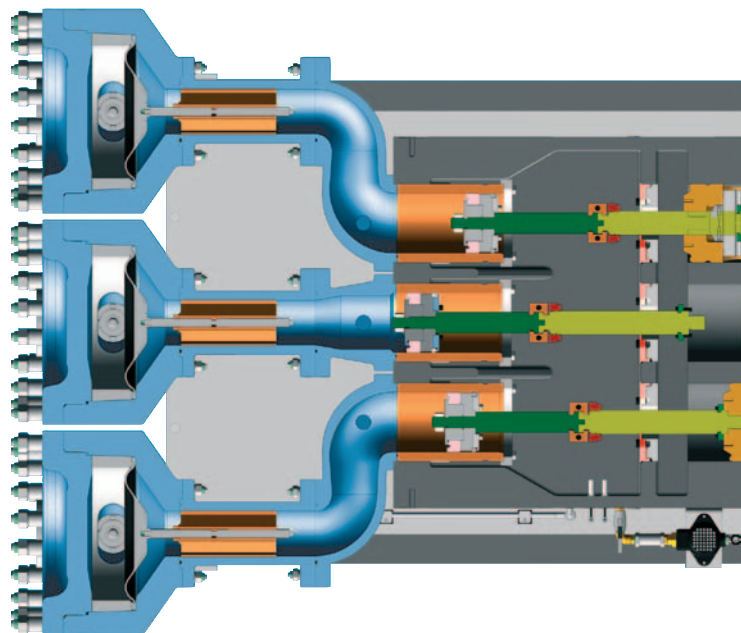

Pump flow can be regulated using a frequency converter. If required, the gearbox of this series is provided with an external forced oil lubrication system as standard. The flow rate can be regulated automatically using a pressure sensor or other 4-to-20 mA signals. A precision-tuned pulsation dampener (suction side and discharge side) is included in the scope of supply.

### Applications and application areas

ABEL HMT pumps can be used to transfer a variety of different types of high-viscosity ash and mine slurries. They offer the chemicals industry an attractive alternative to conventional plunger pumps and piston pumps, particularly for low flow applications.

ABEL pumps have been used around the world for over 50 years for mine dewatering and tailings transfer. A large number of ABEL pumps are currently in operation in the mining industry, power plants and the metal-processing industry.

**THE KONKOLA COPPER MINE** in Chingola (Zambia) processes copper slurry with thickeners and cyclones and, with the help of ABEL HMT pumps, transfers it 3.5 km to the inside of the mine for backfilling.

Two ABEL HMT-F-160-1000 pumps are used to transfer the slurry. Up to 60% of the slurry is solid matter. The flow rate of the pumps is 90 m<sup>3</sup>/h (395 GPM), and a pressure of 5.0 MPa (725 psi) is needed to cover the distance of 3.5 km.

Operating costs have remained very low since the first pump was commissioned. Thanks to the HMT's high efficiency, energy consumption for 90 m<sup>3</sup>/h and 50 bar has been less than 160 kW.

Spare parts for the HMT are only required when replacing the cone valves every 5,000 to 7,000 hours.

The diaphragm are replaced every 12,000 to 16,000 hours as a precautionary measure. This positive track record led the customer to purchase a second pump of the same type.

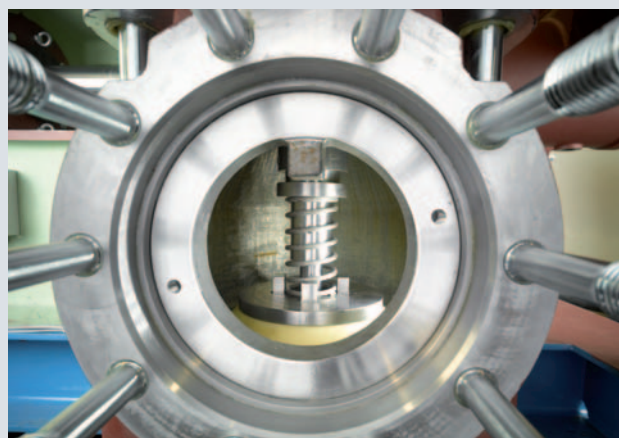

API cone valves for pressures > 4.0 MPa (580 psi) and for mineral slurries with high solids concentration

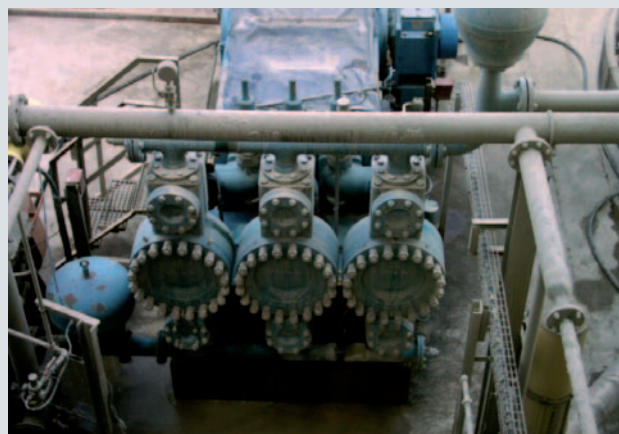

Diaphragm life times over 8,000 hours are not uncommon and proven on continuous duty

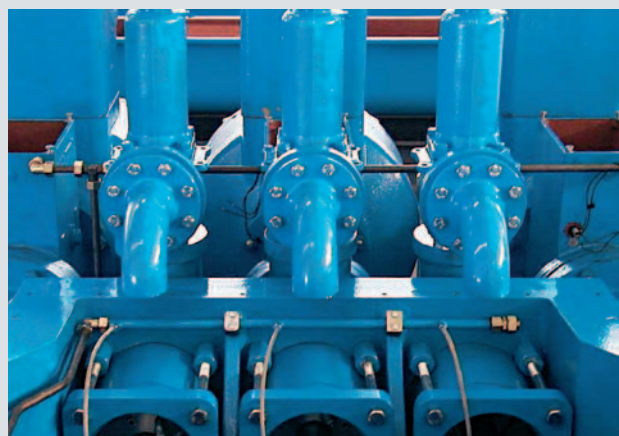

Full-stroke pressure relief valves on the hydraulic side

## ABEL HMQ Hydraulic Quadruplex Diaphragm Pumps



Performance range: up to 450 m<sup>3</sup>/h (1981 GPM); up to 23.0 MPa (3335 psi)

THE ABEL HMQ is a quadruple acting piston diaphragm pump that is primarily used for high flow applications up to 450 m<sup>3</sup>/h (1981 GPM) and a pump pressure of up to 23.0 MPa (3335 psi).

The two pistons on a quadruple acting pump are offset relative to one another by a crank angle of 90°. The result is that a different piston surface generates pump flow after each 90° crank angle. Since the front side of the piston is larger than the rear side of the piston (the piston rod diameter reduces its surface area), different volumes develop on the two sides of the piston; this imbalance would reveal itself as high residual pulsation if an appropriately sized pulsation

dampener were not used. The HMQ series is equipped with an eccentric shaft and an integrated, double-helical reduction gear section. An external forced oil lubrication system is used for lubrication. This gives the gearbox a very compact, robust design.

These gearboxes have been part of the ABEL line-up for over 35 years. This trusted technology, combined with the modern technology of the HM Series, produced the HMQ Series, which represents a competitive alternative to conventional piston pumps and piston diaphragm pumps, particularly for the pressure range below 23.0 MPa (3335 psi).

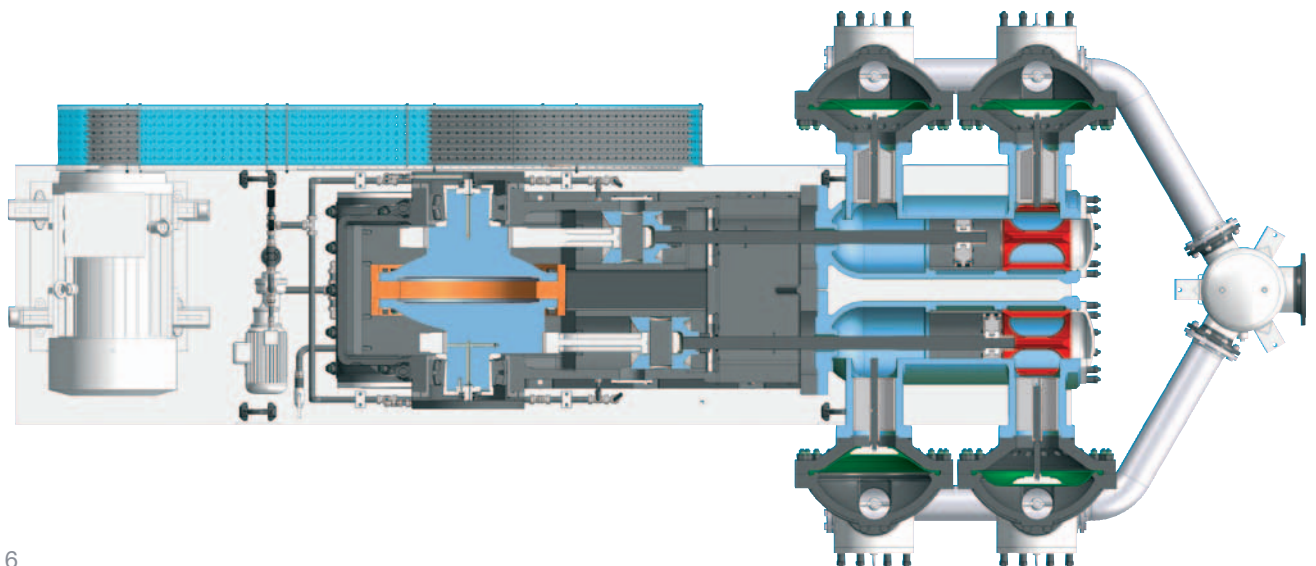



ABEL IMPD  
(intelligent membrane/  
diaphragm type pulsation  
dampener)  
Constant dampening at  
varying pressures

#### Applications and application areas

HMQ series piston diaphragm pumps are being used successfully around the world for applications as diverse as transferring phosphate slurry, feeding filter presses in the cement industry, backfilling in salt mines, as well as pumping ore slurry, fly ash and bottom ash.

Low pressure HMQ series pumps are a particularly attractive alternative to using single-stage or multistage centrifugal pumps to pump mine slurry and fly ash.

The higher purchase price of a piston diaphragm pump is offset by lower energy costs that come from greater efficiency and by a reduced need for maintenance.

Since piston diaphragm pumps easily handle mixtures with high solids concentrations, the amount of water in the medium can also be reduced significantly in some cases. The performance curve of HMQ series pumps is stable with regard to the pressure, which makes it easier to accurately calculate hard-to-find pressure losses.



ABEL HMQ with reverse valves for transfer of fly ash with portions of coarse bottom ash



ABEL HMQ with stainless steel wet ends for transporting brine slurry



ABEL HMQ with duplex stainless steel wet ends for autoclave feed



Diaphragm Pumps  
Solids Handling Pumps  
High Pressure Pumps  
Marine Pumps

AUSTRALIAN DISTRIBUTOR



**KelairPumps**

CALL 1300 789 466

*When Pump Knowledge Matters*

[www.kelairpumps.com.au](http://www.kelairpumps.com.au)