



Goulds 3393

High Pressure, Multistage Ring Section Pump



ITT

ENGINEERED FOR LIFE

Goulds 3393

Lower Total Cost of Ownership (TCO) for demanding, high-pressure applications

Everything about the ITT Goulds 3393 multistage ring section pump is designed to minimize your Total Cost of Ownership. Simply put, it's more efficient, more reliable, and less expensive to maintain than conventional high-pressure pumps. Here's why:

Lower Energy Costs

The 3393 conserves energy by delivering maximum pump efficiency. The integrated diffuser and interstage casing are cast as a single component rather than as two separate pieces. This results in smoother flow transition, which significantly reduces hydraulic losses.

Performance testing on the 3393 has shown a two- to three-point improvement over traditional designs. This added efficiency can mean big energy savings because the same job can be done using less horsepower. For example, a 3393 in continuous operation that consumes 20 less horsepower (15 kW) will save \$65,000 over a five-year period if energy costs are \$0.10/kWh.

Plus, the 3393 doesn't just start efficient, it stays efficient. Standard casing rings provide an easily replaceable wear surface to restore original efficiencies.

Lower Maintenance Costs

Maintenance and inspection are simplified in the 3393 because the balance drum is accessible and removable from the discharge side of the pump. To further aid disassembly, puller holes are provided in the major components.

When you examine all the factors, it's clear that the Goulds 3393 from ITT delivers the kind of total cost of ownership savings that desalination plants and other industrial facilities need today.

Higher Reliability

Every Goulds 3393 is equipped standard with *i-ALERT™*, an onboard condition monitoring device. It provides a visual indication if vibration and temperature limits are reached. This highly reliable early-warning device can avoid a great deal of unplanned downtime and process disruption costs over the life of the pump.

In addition the 3393 has an integrated diffuser and interstage casing which eliminates the fit and machining tolerance between the two parts. A shorter bearing span provides a stiffer shaft with less sag and less chance of wear surface contact at start up. And impellers can be machined to accept impeller wear rings to improve wear resistance and increase useful impeller life. All these things contribute to a more reliable pump.

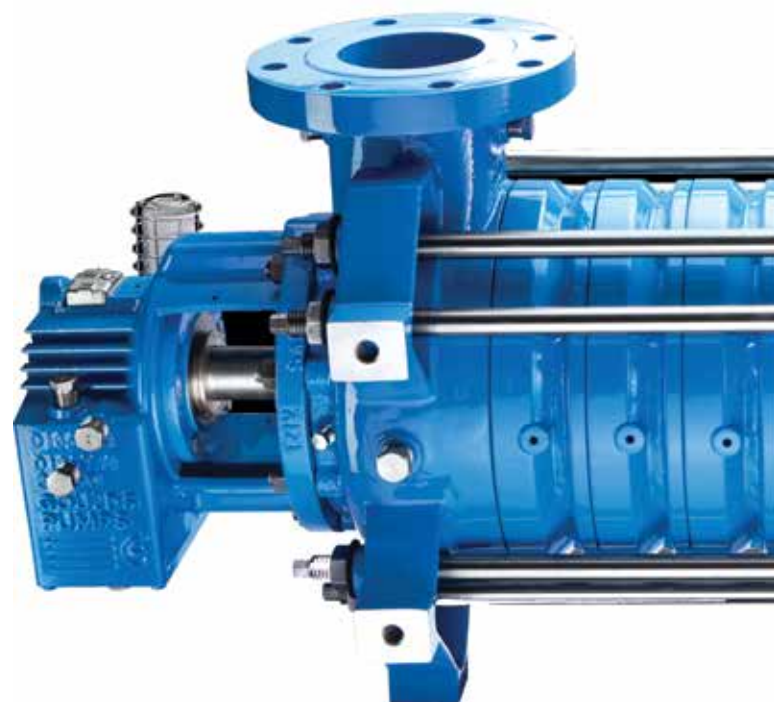

Choose ITT to always lower your total cost of ownership.

Total cost of ownership is the most comprehensive way to identify the true expenses associated with operating and maintaining pumps and related equipment. Initial price is a small fraction—on average just 10 percent—of what you'll spend to operate equipment over its lifetime.

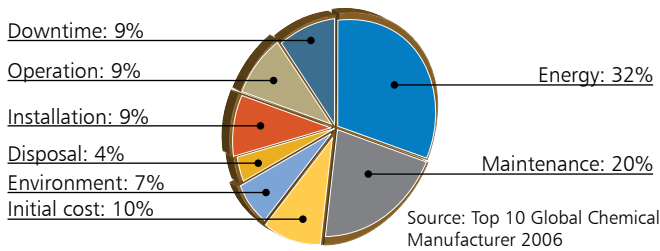

Of the remaining costs, the majority can be minimized by careful attention to all aspects of owning and operating a pump. Nobody does this better than ITT. Let's take a closer look to see how:

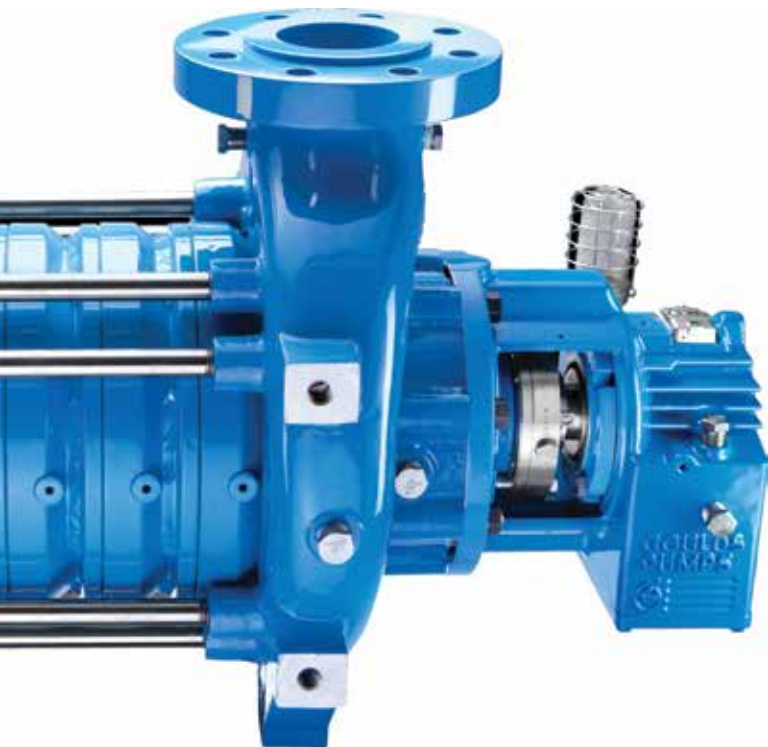

Reliability

With over 160 years of pumping experience, ITT sets the standard for increasing mean time between failures. Plus, with our worldwide sales and service reach you have access to industry experts to resolve your process needs or to evaluate and upgrade your equipment.

What's more, ITT offers innovative ways to keep you in touch with your pumps so you can keep them operating reliably. Our patented *i-ALERT*[™] provides a simple, early indication of change in a pump's operational signature. PumpSmart[®] and ProSmart[®] systems deliver continual feedback and control.

Maintenance

ITT is unrivaled in supplying parts globally. And, because our equipment is easier to inspect and repair than many competitors', you can get up and running quickly and minimize production losses. When repairs are necessary, our modular designs reduce inventory costs while covering a wide hydraulic window. ITT's worldwide presence puts aftermarket services where you most need them to keep your equipment running at peak performance.

Energy

ITT designs for the highest efficiency. Our wide range of models and sizes coupled with multiple hydraulic selections allows us to tailor pump performance to your process. The right pump saves energy and lowers your costs.

These factors are just the beginning. ITT has carefully thought out every aspect of Total Cost of Ownership to provide maximum value with every purchase. In addition, we offer a full suite of Plant Performance Services designed to reduce your ownership costs even more.

Specifications

General

- Radially split, segmented casing, multistage pump
- Modular interstage components
- Radial and end suction configuration
- Materials: 12% chrome, duplex and super duplex stainless steels
- High efficiency

Pressure and Temperature Limits

- All: 350°F
- Top (ES) or top-top (RS) arrangement must be used for temperatures over 250°F
- All: 350 psig suction pressure
- Duplex/super duplex: 1480 psig discharge pressure
- 12% chrome: 1687 psig discharge pressure

Suction and Discharge Casings

- Flanges raised face per ANSI/ISO or EN/DIN specifications
- Radial and end suction available for suction casing
- Product lubricated silicon carbide sleeve bearing for end suction pump
- Dual volute type discharge casing
- Radial suction and discharge casing nozzles positioned in 90° increments.
- Casing wear rings standard

Interstage Casings

- Rigid, heavy duty parts
- One piece combined continuous channel multivane diffuser and stage piece
- Casing wear rings standard

Impellers

- Enclosed type
- Precision investment cast
- Keyed to the shaft
- Dynamically balanced
- Two impeller designs (min) for each pump size
- Optional impeller wear rings

Shafts

- Impeller keyways staggered for better balance

Balancing Device

- Involute balance drum for axial thrust balance
- Dual step surface for closer running clearance
- Accessible and removable from the discharge side of the pump

Instrumentation

- Bearing frames pre-machined for temperature and vibration sensors
- *i-ALERT™* standard

Seals and seal systems

- Single and double cartridge mechanical seals
- Standard seal flush plan modified plan 11/13
- Seal chamber accepts a mechanical seal with pumping ring
- Plan 11, 23 as options

Bearing housings

- Radial suction pump bearing housings identical on suction and discharge ends
- Inpro VBXX-D™ labyrinth seals are standard
- Bearing housings are finned and fanned for additional cooling

Bearings

- End suction sleeve bearing supported in the suction casing
- Heavy duty anti-friction bearings in bearing housings
- Oil lubricated anti-friction bearings

Couplings

- Disc type spacer coupling standard

Coupling guards

- Standard
- Comply with OSHA and EN requirements

Shaft guards

- 304SS expanded metal shaft guards cover bearing housing openings

Baseplates

- Rigid fabricated steel design
- Reduced vibration
- Assured positive alignment

Drivers

- Electric motor
- Steam turbine
- Diesel engine
- Speed increasing or reducing gears

Certifications

- CE marking and ATEX certification

Hydraulic Coverage

60 Hz

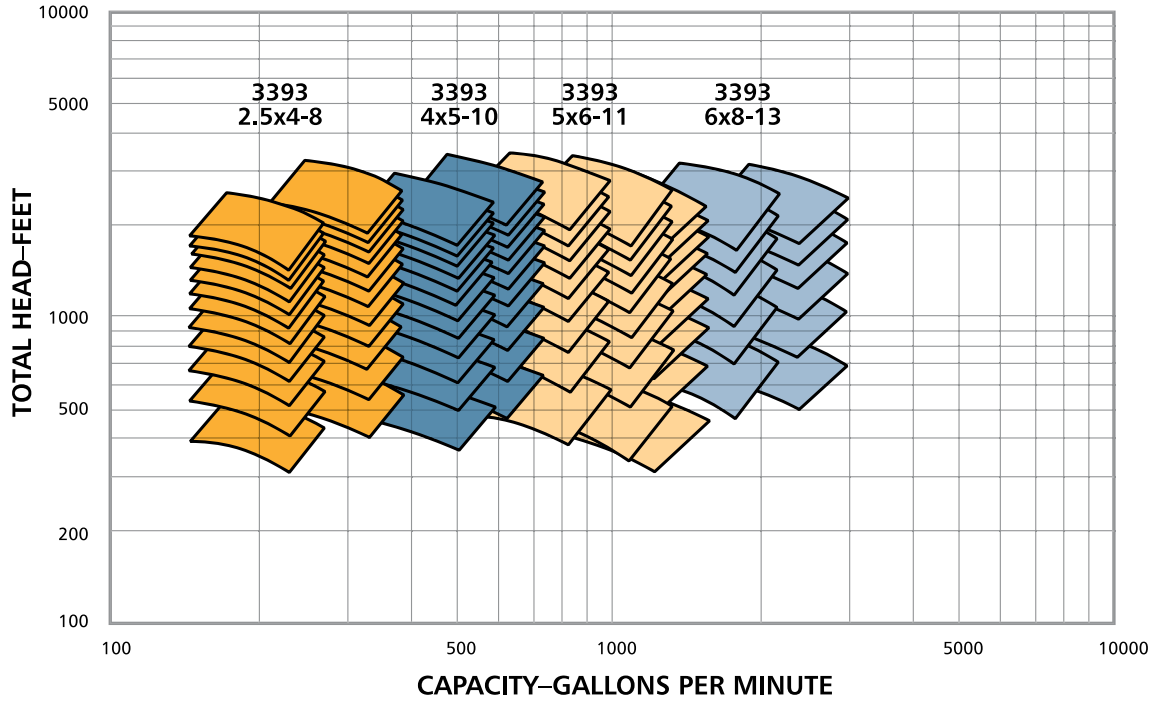

50 Hz

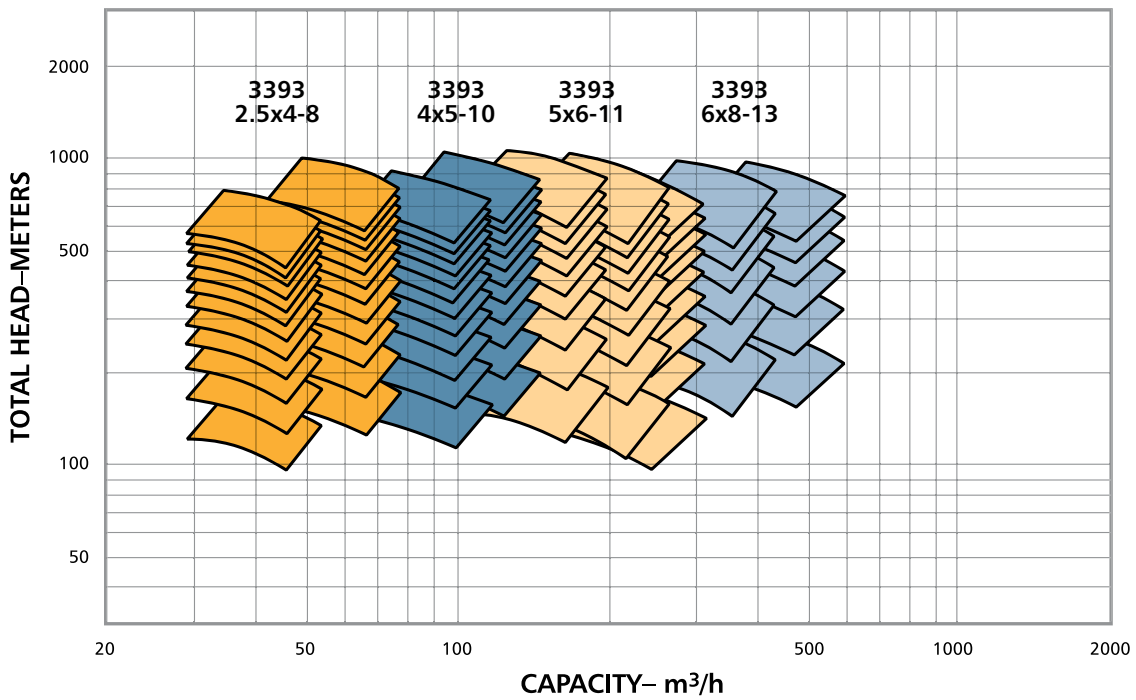

Goulds 3393

High Pressure, Multistage Ring Section Pumps

DUAL VOLUTE TYPE DISCHARGE CASING

- Improved efficiency
- Lower Radial Loads

INVOLUTE BALANCE DRUM

- Involute configuration reduces installation footprint
- Accessibility from discharge side simplifies maintenance
- Dual step surface yields reliability under all conditions

SEAL CHAMBER

- Accepts a range of mechanical seals and piping plans

RUGGED BEARING HOUSING

- Finned and fanned for additional cooling
- Instrumentation ready
- Heavy duty anti-friction bearings

PRECISION CAST CONTINUOUS CHANNEL

DIFFUSER/STAGE CASING

- Integrated design simplifies alignment for ease of maintenance
- Smooth flow transition reduces hydraulic losses

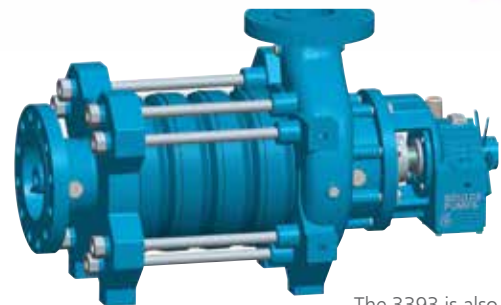
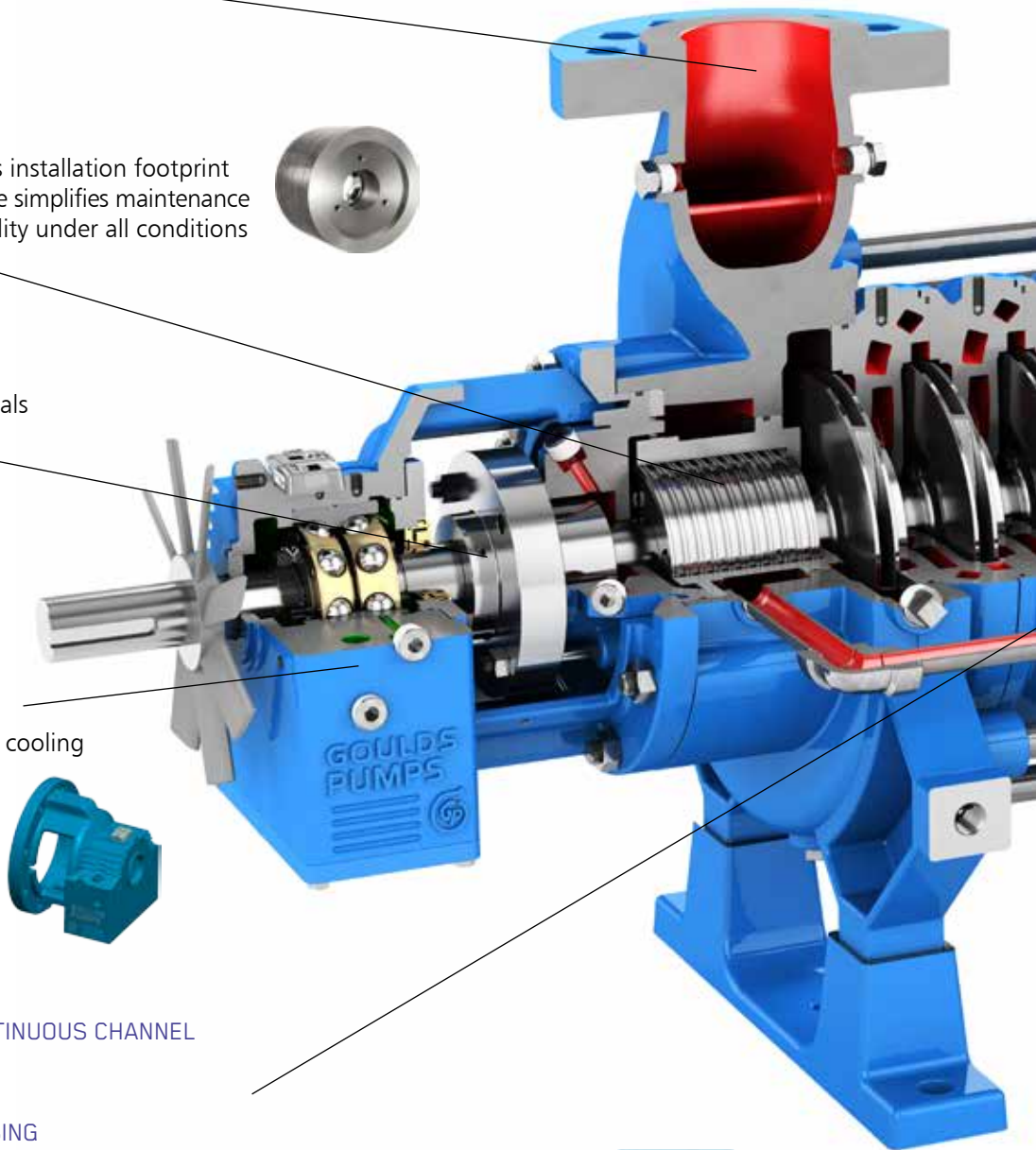



i-ALERT™ CONDITION MONITOR

- Proprietary on-board condition monitoring integrated with bearing housings is standard
- Early visual indication of operating performance facilitates proactive maintenance practices

CASING WEAR RINGS

- Standard on all pumps

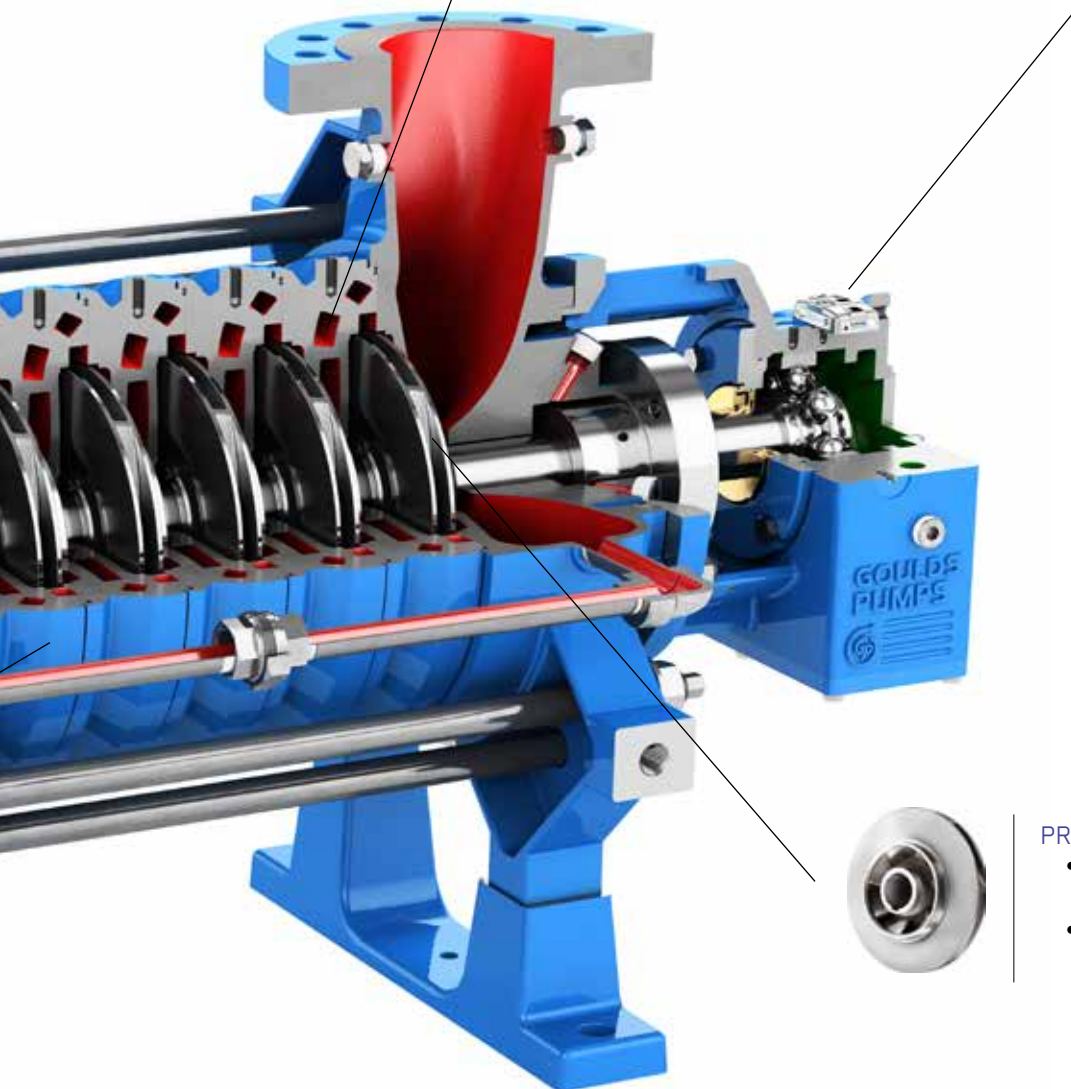

PRECISION CAST IMPELLER

- Optional impeller wear ring renews efficiencies to as-new condition
- Multiple hydraulic designs maximize efficiency for customer applications



DESIGNED TO MINIMIZE YOUR TOTAL COST OF OWNERSHIP

Features:

- Designed for world class efficiency and reliability
- Precision cast components
- Modular design
- End or radial suction configurations
- Multiple hydraulics
- Multiple nozzle orientations for radial suction pump

Applications:

- Reverse osmosis
- Boiler feed
- Cogeneration
- Shower / spray service
- Pressure boosting
- High pressure cleaning
- Snow making

Sectional View

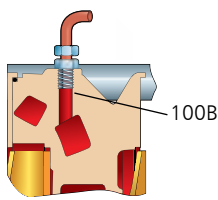
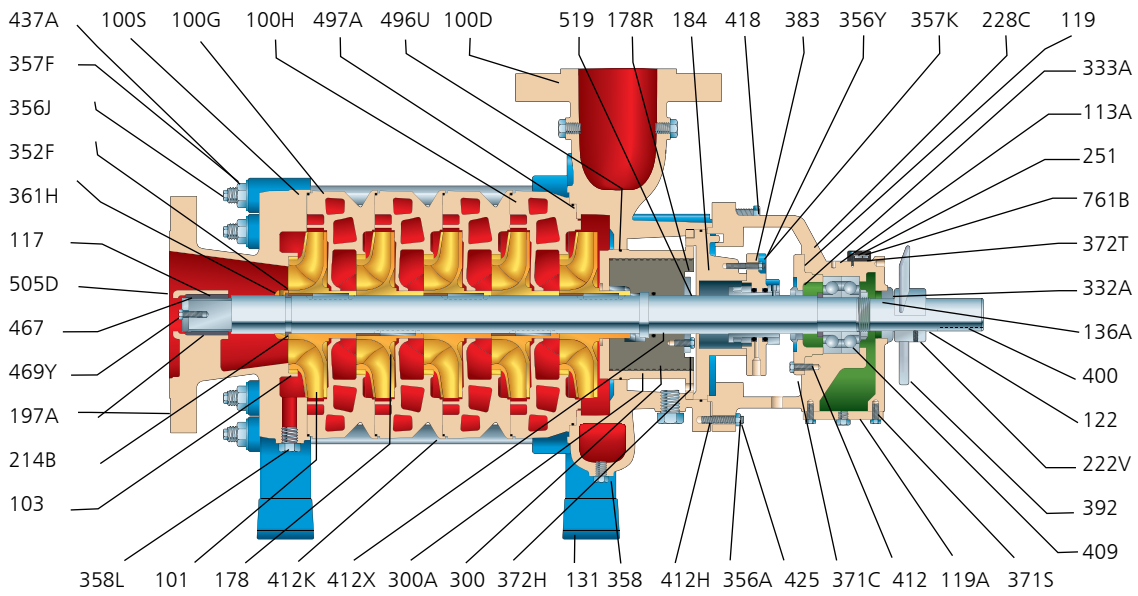
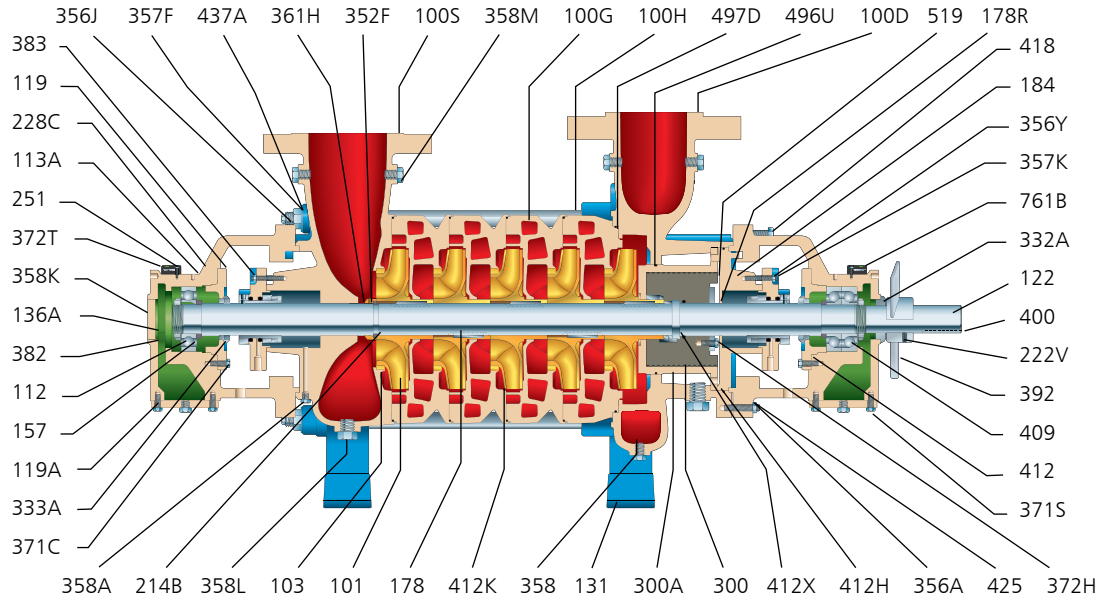

3393 Optional Tapping

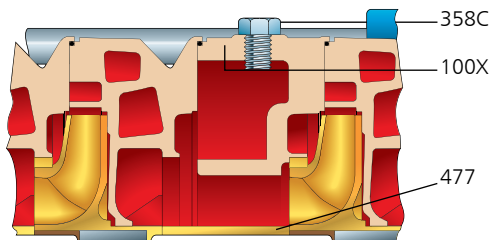

3393 Optional Interstage

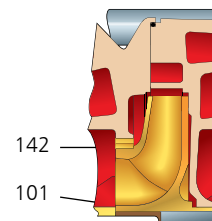

3393 Optional Impeller Wear Rings

Parts List and Materials of Construction

Item Number	Description	Materials		
		Chrome Steel	Duplex	Super Duplex
100B	1st Stage Remachine for Plan 11 takeoff	12 Chrome	Duplex SS	Super Duplex SS
100D	Casing (Discharge)	12 Chrome	Duplex SS	Super Duplex SS
100G	Diffuser Stage Casing	12 Chrome	Duplex SS	Super Duplex SS
100H	Diffuser Final Stage Casing	12 Chrome	Duplex SS	Super Duplex SS
100S	Casing (Suction)	12 Chrome	Duplex SS	Super Duplex SS
100X	Casing (Destaging and Takeoff - Optional)	12 Chrome	Duplex SS	Super Duplex SS
101	Impellar (Series)	12 Chrome	Duplex SS	Super Duplex SS
103	Case Wear Ring (Standard Clearance)	Nitronic 60 + PEEK		PEEK
112	Ball Bearing (Radial)		Steel	
113A	Breather		Steel	
117	Bearing Sleeve (End Suction Only)		Silicon Carbide	
119	Cover (Bearing Housing)		Ductile Iron	
119A	Cover (Bearing Housing Sump)		Steel	
122	Shaft	17-4 PH	Duplex SS	
131	Foot		Steel	
136A	Bearing Lock Nut		Steel	
142	Impellar Wear Ring (Optional)	17-4 PH	Duplex SS	
157	Bearing Spacer		Carbon Steel	
178	Key (Impeller)	17-4 PH	Duplex SS	
178R	Key (Balance Drum)	17-4 PH	Duplex SS	
184	Seal Chamber	12 Chrome	Duplex SS	Super Duplex SS
197A	Bearing Bushing (End Suction Only)		Silicon Carbide	
214B	Split Ring	17-4 PH	Duplex SS	
222V	Set Screw (Fan) On 5"(125) and 6"(150) Pumps Only		316 SS	
228C	Bearing Housing		Ductile Iron	
251	Oiler (Constant Level)		Aluminum/Glass	
300	Balance Drum	12 Chrome	Duplex SS	Super Duplex SS
300A	Balance Drum Stator	12 Chrome	Duplex SS	Super Duplex SS
332A	Bearing Isolator (Outboard)		Bronze/Viton	
333A	Bearing Isolator (Inboard)		Bronze/Viton	
352F	Set Screw (Retaining Ring)	316 SS		20Cb3 SS
356A	Stud (Bearing Housing to Suction/Discharge Casing)		Alloy Steel	
356J	Tie Rod		4140 Steel	
356Y	Stud (Seal Chamber)		316 SS	
357F	Nut (Tie Rod)		Alloy Steel	
357K	Nut (Seal Chamber)		316 SS	
358	Drain Plug (Casing)	316 SS		20Cb3 SS
358A	Plug (Seal Chamber Flush)	316 SS		20Cb3 SS
358C	Plug (Destage Casing)	316 SS		20Cb3 SS
358K	Plug (Balance Housing Opening)		Carbon Steel	
358L	Plug (Balance Return)	316 SS		20Cb3 SS
358M	Plug (Casing Branch Tapping)	316 SS		20Cb3 SS
361H	Retaining Ring	17-4 PH		Duplex SS
371C	Cap Screw (Bearing Housing Cover)		316 SS	
371S	Cap Screw (Bearing Housing Sump Cover)	316 SS		
372H	Cap Screw (Bearing Drum Locking Plate)	316 SS		20Cb3 SS
372T	Cap Screw (i-ALERT® to Bearing Housing)		316 SS	
382	Bearing Lock Washer		Steel	
383	Mechanical Seal			
392	Fan (Brg. Cooling)		Aluminum	
400	Key (Coupling)		1018 Steel	
409	Ball Bearing (Thrust)		Steel	
412	O Ring (Bearing Housing Cover)		Buna-N	
412H	O Ring (Seal Chamber)		EPDM	
412K	O Ring (Diffuser Stage Casing)		EPDM	
412X	O Ring (Balance Drum)		EPDM	
418	Cap Screw (Bearing Housing Jacking)		316 SS	
424	Screw (Shaft Guard - Optional)		304 SS	
425	Nut (Bearing Housing to Suction/Discharge Casing)		Alloy Steel	
437A	Washer (Tie Rod)		Carbon Steel	
467	Retaining Plate (Bearing Bushing) End Suction Only	17-4 PH		Duplex SS
469Y	Cap Screw (Retaining Plate to Shaft) End Suction Only	316 SS		20Cb3 SS
477	Sleeve (Destaging and Takeoff)	17-4 PH		Duplex SS
496U	O Ring (Balance Drum Stator)		EPDM	
497D	O Ring (Discharge Casing)		EPDM	
499	Guard (Shaft - Optional)		304 SS	
505D	Tolerance Ring (Bearing Sleeve) End Suction Only		Hastelloy C	
519	Locking Plate (Balance Drum)	12 Chrome		Super Duplex SS
534C	Bolt Retainer (Guard To Bearing Housing)		Steel	
569F	Cap Screw (Guard to Bearing Housing)		316 SS	
761B	i-ALERT®		Stainless Steel/Epoxy	

Dimensions

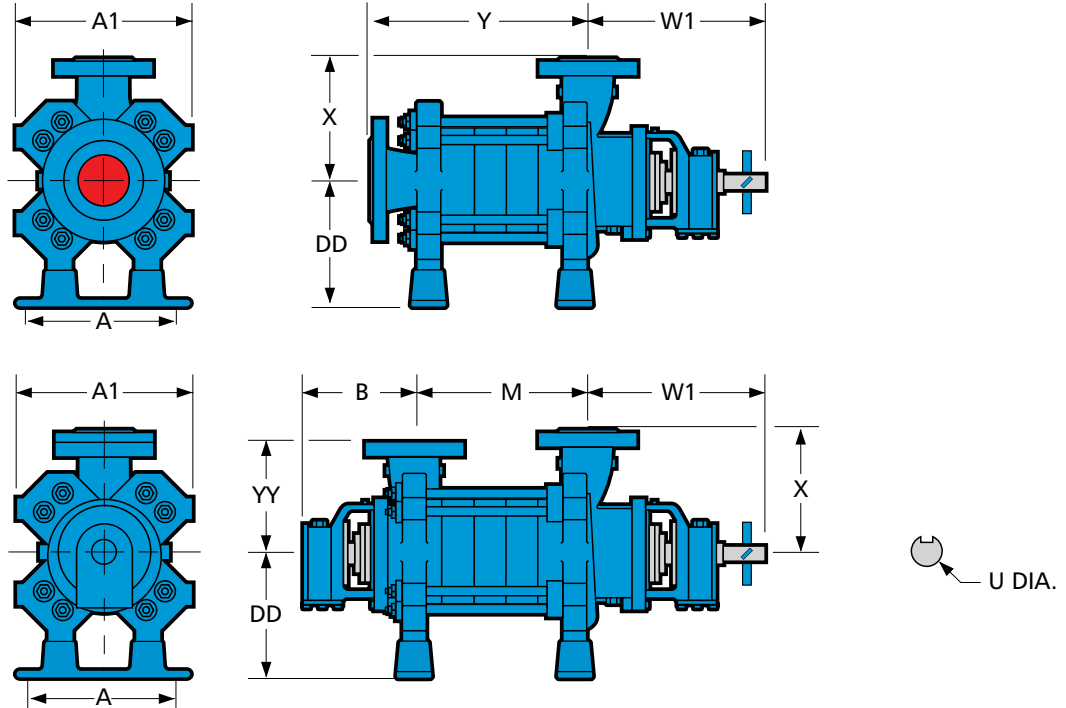

DIMENSIONS											
Size	Suction Flange (in.)		Discharge Flange (in.)	A	A1	U	DD	X	YY	W1	B
	ES	RS									
2.5x4-8A, B	5 (125)	4 (125)	2.5 (65)	14.25 (362)	17.32 (440)	1.46 (37)	12.50 (318)	10.43 (265)	10.43 (265)	19.00 (483)	13.36 (339)
4x5-10A, B	6 (150)	5 (125)	4 (125)	15.50 (394)	20.08 (510)	1.65 (42)	14.25 (362)	13.58 (345)	11.81 (300)	19.54 (496)	13.78 (350)
5x6-11A,B	8 (200)	6 (150)	5 (125)	17.50 (445)	23.23 (590)	2.05 (52)	16.00 (406)	15.55 (395)	13.98 (355)	23.13 (588)	15.02 (382)
5x6-11C	8 (200)	6 (150)	5 (125)	17.50 (445)	23.23 (590)	2.05 (52)	16.00 (406)	15.55 (395)	13.98 (355)	23.42 (595)	15.02 (382)
6x8-13A	10 (250)	8 (200)	6 (150)	19.75 (502)	28.75 (730)	2.60 (66)	18.25 (464)	17.52 (445)	17.24 (438)	24.92 (633)	16.97 (431)
6x8-13B	10 (250)	8 (200)	6 (150)	19.75 (502)	28.75 (730)	2.60 (66)	18.25 (464)	19.09 (485)	17.24 (438)	24.92 (633)	16.97 (431)

NUMBER OF STAGES														
Size	Type	2	3	4	5	6	7	8	9	10	11	12	13	14
		in (mm)	in (mm)	in (mm)	in (mm)	in (mm)	in (mm)	in (mm)	in (mm)	in (mm)	in (mm)	in (mm)	in (mm)	in (mm)
2.5x4-8A	Y	9.35 (237)	11.64 (296)	13.92 (354)	16.20 (411)	18.49 (470)	20.77 (528)	13.05 (331)	25.34 (644)	27.62 (702)	29.90 (759)	32.19 (818)	34.47 (876)	36.75 (933)
	M	5.86 (149)	8.14 (207)	10.43 (265)	12.71 (323)	14.99 (381)	17.28 (439)	19.56 (497)	21.84 (555)	24.13 (613)	26.41 (671)	28.69 (729)	30.98 (787)	33.26 (845)
2.5x4-8B	Y	9.70 (246)	12.26 (311)	14.82 (376)	17.38 (441)	19.93 (506)	22.49 (571)	25.05 (636)	27.61 (701)	30.17 (766)	32.73 (831)	35.29 (896)	37.85 (961)	40.41 (1026)
	M	5.86 (149)	8.14 (207)	10.43 (265)	12.71 (323)	14.99 (381)	17.28 (439)	19.56 (497)	21.84 (555)	24.13 (613)	26.41 (671)	28.69 (729)	30.98 (787)	33.26 (845)
4x5-10A	Y	11.87 (301)	14.70 (373)	17.54 (446)	20.37 (517)	23.21 (590)	26.04 (661)	28.88 (734)	31.71 (805)	34.55 (878)	37.38 (949)	40.22 (1022)	43.05 (1093)	45.89 (1166)
	M	7.54 (192)	10.37 (263)	13.21 (336)	16.04 (407)	18.88 (480)	21.71 (551)	24.55 (624)	27.38 (695)	30.22 (768)	33.05 (839)	35.89 (912)	38.72 (983)	41.56 (1056)
4x5-10B	Y	12.19 (310)	15.33 (389)	18.48 (469)	21.63 (549)	24.78 (629)	27.93 (709)	31.11 (790)	34.23 (869)	37.38 (949)	40.53 (1029)	43.68 (1109)	46.83 (1189)	49.98 (1269)
	M	7.85 (199)	11.00 (279)	14.15 (359)	17.30 (439)	20.45 (519)	23.60 (599)	26.75 (679)	29.90 (759)	33.05 (839)	36.20 (919)	39.35 (999)	42.50 (1080)	45.65 (1160)
5x6-11A	Y	14.65 (372)	18.58 (472)	22.52 (572)	26.46 (672)	30.39 (772)	34.33 (872)	38.27 (972)	42.20 (1072)	46.14 (1172)				
	M	9.53 (242)	13.46 (342)	17.40 (442)	21.34 (542)	25.28 (642)	29.21 (742)	33.15 (842)	37.09 (942)	41.02 (1042)				
5x6-11B	Y	14.65 (372)	18.58 (472)	22.52 (572)	26.46 (672)	30.39 (772)	34.33 (872)	38.27 (972)	42.20 (1072)	46.14 (1172)				
	M	9.53 (242)	13.46 (342)	17.40 (442)	21.34 (542)	25.28 (642)	29.21 (742)	33.15 (842)	37.09 (942)	41.02 (1042)				
5x6-11C	Y	10.06 (256)	14.39 (366)	18.72 (475)	23.05 (585)	27.38 (695)	31.71 (805)	36.04 (915)	40.37 (1025)	44.70 (1135)				
	M	14.65 (372)	18.58 (472)	22.52 (572)	26.46 (672)	30.39 (772)	34.33 (872)	38.27 (972)	42.20 (1072)	46.14 (1172)				
6x8-13A	Y	17.38 (441)	22.11 (562)	26.83 (681)	31.55 (801)	36.28 (922)	41.00 (1041)							
	M	11.38 (289)	16.10 (409)	20.83 (529)	25.55 (649)	30.27 (769)	35.00 (889)							
6x8-13B	Y	18.29 (465)	23.60 (599)	28.92 (735)	34.23 (869)	39.55 (1005)	44.86 (1139)							
	M	12.28 (312)	17.60 (447)	22.91 (582)	28.23 (717)	33.54 (852)	38.86 (987)							

Full Portfolio of Multistage Pumps

Ring Section

Axially Split



Model 3393
(End or radial suction)



Model 3355
(End or radial suction)



Model 3600



Model 3316

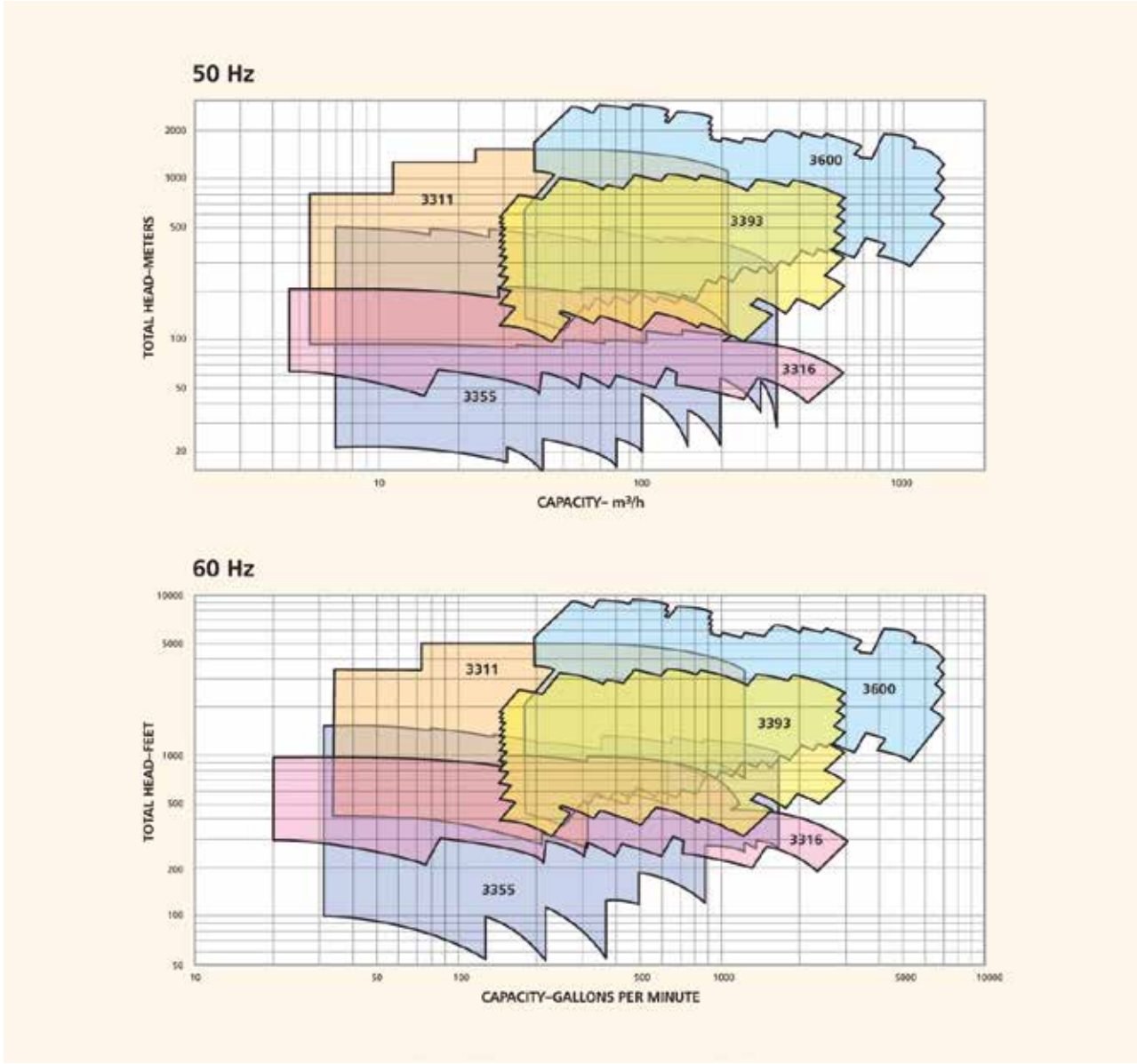

Visit our website at
www.gouldspumps.com

Wherever you are, we're there too.

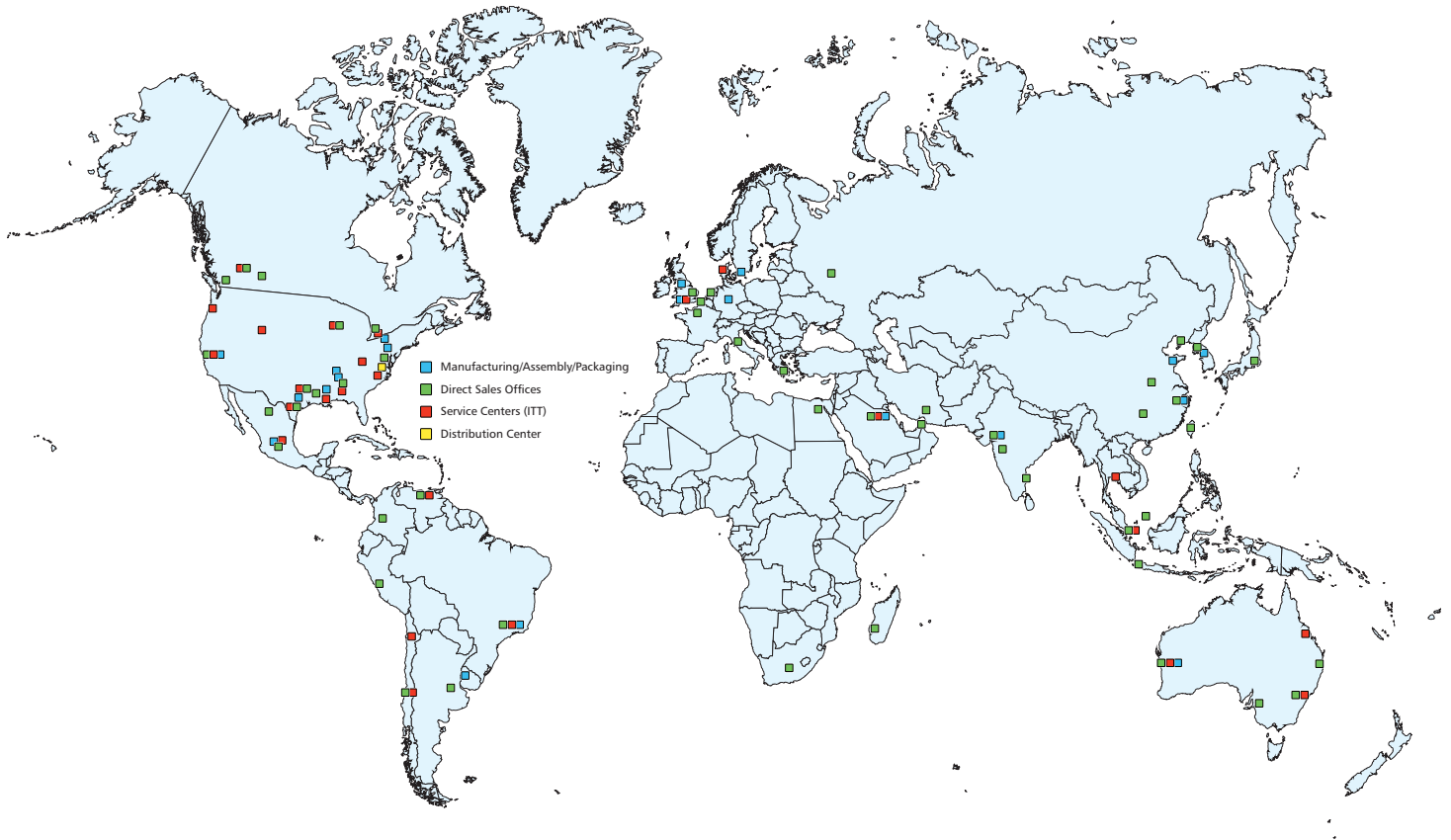

Reliability has no quitting time.

Building on over 160 years of Goulds Pumps experience, PRO Services provides an array of services focused on reducing equipment total cost of ownership (TCO) and increasing plant output, including predictive monitoring, maintenance contracts, field service, engineered upgrades, inventory management, and overhauls for pumps and other rotating equipment.

Your Total Solution For Equipment Life Cycle Optimization

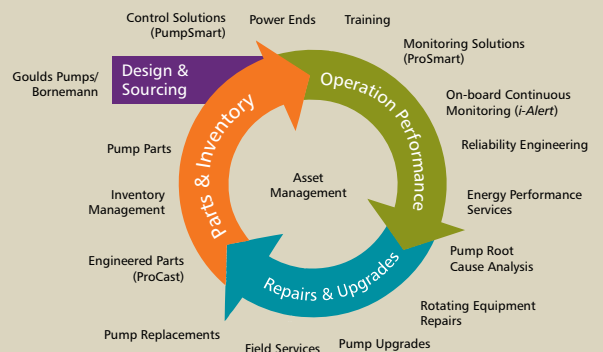

© 2014 ITT Corporation, Inc.

B.3393.en-US.2015-07



240 Fall Street
Seneca Falls, NY 13148
www.itt.com



AUSTRALIAN DISTRIBUTOR



CALL 1300 789 466
When Pump Knowledge Matters
www.kelairpumps.com.au