



KelairPumps

CALL 1300 789 466

When Pump Knowledge Matters

www.kelairpumps.com.au

it	P-PSA-BG-BGM GARDEN-SP-CEA-CA HM-HMS	Istruzioni installazione ed uso - Sicurezza - Dichiarazione di conformità
en	P-PSA-BG-BGM GARDEN-SP-CEA-CA HM-HMS	Instructions for installation and use - Safety - Declaration of conformity
fr	P-PSA-BG-BGM GARDEN-SP-CEA-CA HM-HMS	Instructions pour installation et l'emploi - Sécurité – Déclaration de conformité
de	P-PSA-BG-BGM GARDEN-SP-CEA-CA HM-HMS	Installations- und Bedienungsanleitungen – Sicherheit – Konformitätserklärung
es	P-PSA-BG-BGM GARDEN-SP-CEA-CA HM-HMS	Instrucciones de instalación y uso. Seguridad. Declaración de Conformidad.
pt	P-PSA-BG-BGM GARDEN-SP-CEA-CA HM-HMS	Instruções instalação e uso - Segurança - Declaração de conformidade
nl	P-PSA-BG-BGM GARDEN-SP-CEA-CA HM-HMS	Aanwijzingen voor de installatie en het gebruik - Veiligheidsvoorschriften - Verklaring van overeenstemming
da	P-PSA-BG-BGM GARDEN-SP-CEA-CA HM-HMS	Instruktioner vedrørende installation og brug- Sikkerhed - Overensstemmelseserklæring
sv	P-PSA-BG-BGM GARDEN-SP-CEA-CA HM-HMS	Instruktioner för installation och användning - Säkerhet – Försäkran om överensstämmelse
no	P-PSA-BG-BGM GARDEN-SP-CEA-CA HM-HMS	Instruksjoner for installasjon og bruk - Sikkerhet - Overensstemmelseserklæring
fi	P-PSA-BG-BGM GARDEN-SP-CEA-CA HM-HMS	Asennus- ja käyttöohjeet - Turvallisuus - vakuutus yhdenmukaisuudesta
gr	P-PSA-BG-BGM GARDEN-SP-CEA-CA HM-HMS	Οδηγίες εγκατάστασης και χρήσης - Ασφάλεια - Δήλωση συμμόρφωσης
tr	P-PSA-BG-BGM GARDEN-SP-CEA-CA HM-HMS	Yerleştime ve kullanım bilgileri - Emniyet Uygunluk beyanı
ar	P-PSA-BG-BGM GARDEN-SP-CEA-CA HM-HMS	تعليمات التركيب والاستخدام والأمان تصريح صناعة طبق الأصول
r	P-PSA-BG-BGM GARDEN-SP-CEA-CA HM-HMS	Инструкции по установке и эксплуатации - Безопасность - Декларация соответствия
pl	P-PSA-BG-BGM GARDEN-SP-CEA-CA HM-HMS	Instrukcja obsługi - Zasady Bezpieczeństwa - Deklaracja zgodności

1

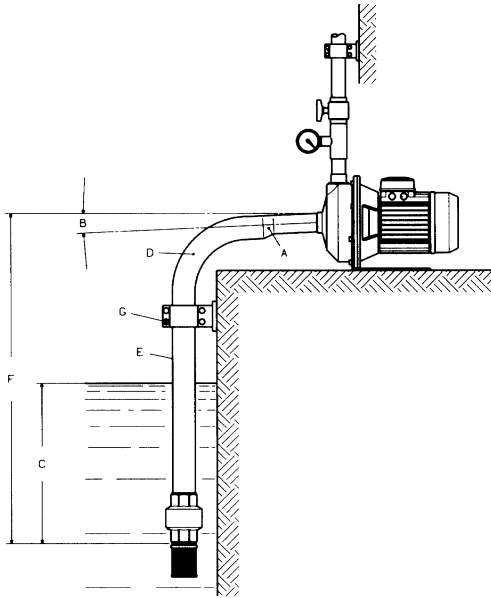

2

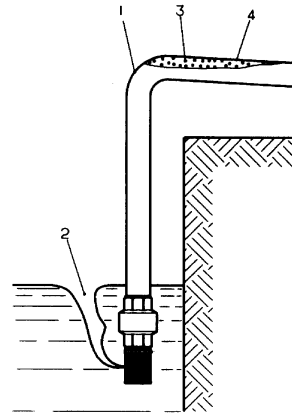

4

$\varnothing = 1,5 \text{ Nm}$

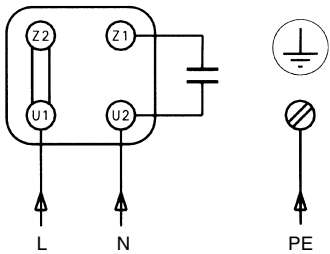
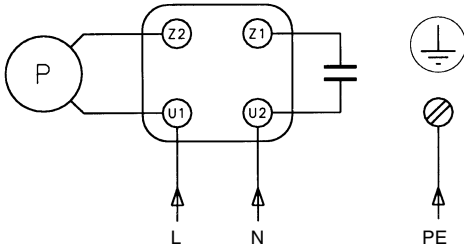
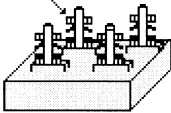

1 ~

$\varnothing = 1,5 \text{ Nm}$

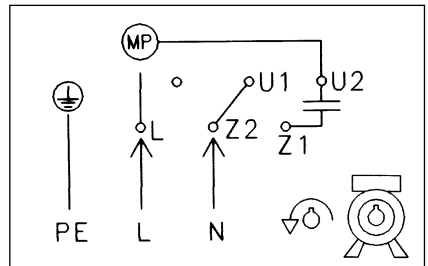
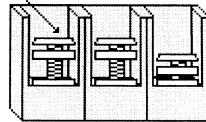

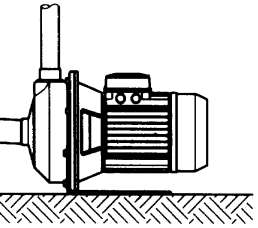

3

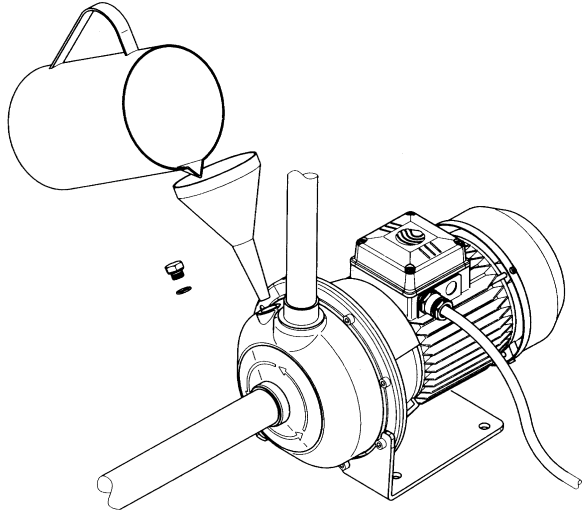

5

$\hookrightarrow = 1,5 \text{ Nm}$

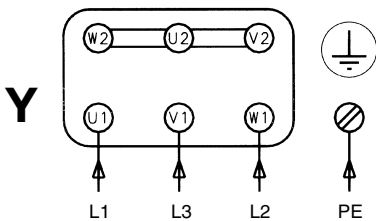
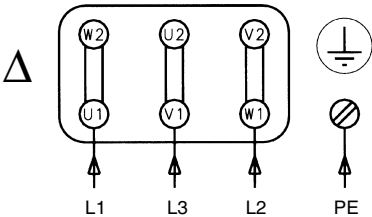
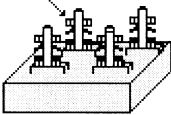

3 ~

$\hookrightarrow = 1,5 \text{ Nm}$

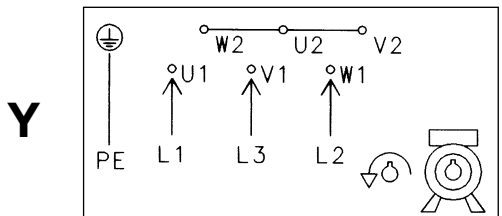
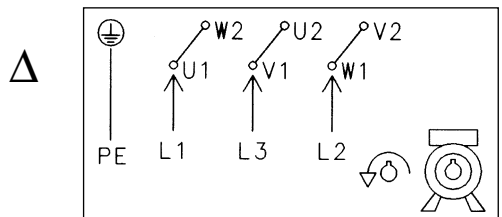
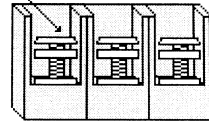

1. MOVIMENTAZIONE

Il prodotto va sollevato e movimentato con cura.

2. IMPIEGHI

Movimentazione di acque pulite non aggressive prive di gas disciolti, con moderata presenza di gas solo per i modelli BG e BGM garden.

Impieghi tipici

Rifornimenti idrici domestici, irrigazioni, pressurizzazione, travasi.

3. LIMITI D'IMPIEGO

- Max pressione d'esercizio: 800 kPa (8 bar), PSA: 1MPa (10bar)
- Max temperatura liquido: P, BG, SP, HM: 40°C; CEA-CA-PSA: 85°C, 110°C in versione ... - V.
- Max temperatura ambiente: 40°C (per 40÷45°C vedere punto 5)
- Max nr. Avviamenti orari: 40

4. INSTALLAZIONE

Fissare l'elettropompa ad una base stabile con opportune viti, utilizzando le asole predisposte sul piede motore.

Installazione corretta (fig. 1)

A = riduzioni eccentriche

B = pendenza positiva

C = buona immersione

D = curve ampie

E = diametro tubo d'aspirazione \geq diametro bocca della pompa

F = dislivello di sollevamento. Dipende dalla pompa e dall'installazione (*)

G = tubazioni non gravanti sulla pompa ma supporti indipendenti

H = valvola di fondo (non indispensabile per modelli SP-BG-SG) (*) Il dislivello di aspirazione è determinato dalla temperatura del liquido, della quota altimetrica, delle perdite di carico e del NPSH richiesto dalla pompa.

Indicativamente il dislivello in aspirazione è 4m per i modelli P e C e 7m per i modelli BG e SP.

Installazione errata (fig. 2)

1 = curva brusca; alte perdite di carico

2 = immersione insufficiente: risucchio d'aria

3 = pendenza negativa: sacche d'aria

4 = diametro tubo < al diametro bocca della pompa: alte perdite di carico.

5. COLLEGAMENTO ELETTRICO

Eseguire i collegamenti come indicato sul retro del coperchio mortasettiera (rotazione antioraria) o in fig. 4 per le versioni monofase e in fig. 5 per le versioni trifase. Usare cavi a normativa con 3 conduttori (2+terra) per versioni monofase e con 4 conduttori (3+terra) per versioni trifase. Le caratteristiche di riferimento (tensione, frequenza e corrente assorbita) sono riportate sulla targhetta della pompa.

Le elettropompe monofase hanno la protezione termoamperometrica a riarmo automatico incorporata; le elettropompe trifase vanno alimentate sempre tramite un salvamotore magneto-termico tarato alla corrente di targa.

Per temperatura ambiente da 40 a 45°C si dovranno utilizzare cavi di alimentazione con caratteristiche di temperatura non inferiore a 95°C e con sezione minima dei conduttori di 1,5 mm².

Controllo del senso di rotazione (solo trifase)

L'esatto senso di rotazione è orario guardando la pompa dal lato motore.

La verifica si effettua a vista, guardando la ventola o controllando la prestazione della pompa.

Il senso di rotazione corretto è quello che genera prestazioni Q/H maggiori. In caso di rotazione contraria invertire tra di loro due fili di alimentazione.

6. ADESCAMENTO (Fig. 3)

Riempire attraverso l'apposito tappo il corpo pompa e il tubo aspirante facendo fuoriuscire tutta l'aria.

Per i modelli SP-BG l'autoadescamento senza valvola di fondo può richiedere anche 3-4 minuti. Per questo si consiglia sempre l'impiego della valvola di fondo.

7. MANUTENZIONE

Qualsiasi intervento sulla pompa deve essere eseguito da personale qualificato previo scollegamento dalla rete. La pompa non richiede manutenzione ordinaria.

1. HANDLING

The product must be lifted and handled with care.

2. APPLICATIONS

Designed to handle clean non-aggressive water free of dissolved gases. For water with moderate gas content, use BG and BGM garden models.

Typical applications.

Domestic water supply, irrigation, pressure boosting, liquid transfer.

3. WORKING LIMITS

- Max. operating pressure: 800 kPa (8 bar), PSA; 1 MPa (10 bar)
- Max. liquid temperature: P, BG, SP, HM: 40°C; CEA-CA-PSA: 85°C, 110°C for ...-V version.
- Max. ambient temperature: 40°C (for 40/45°C see point 5).
- Max. number of starts per hour: 40

4. INSTALLATION

Screw the electric pump to a stable base using the slots in the foot of the motor.

Proper installation (fig. 1)

A = eccentric adapters

B = positive lift

C = good immersion

D = wide bends

E = suction pipe diameter \geq pump port diameter

F = suction lift. Depends on pump and installation (*)

G = pipes must not exert stress on pump but on independent supports

H = foot valve (not necessary for SP-BG-SG models).

(*) The suction lift is determined by liquid temperature, altitude, flow resistance and

NPSH required by the pump.

As a general rule, the suction lift is 4 m for the P and C models, and 7 m for the BG and SP models.

Improper installation (fig. 2)

1 = tight bends: high flow resistance

2 = insufficient immersion: air suction

3 = negative lift: air pockets

4 = pipe diameter < pump port diameter: high flow resistance.

5. ELECTRICAL CONNECTION

To connect, proceed as shown on the back of the terminal board cover (anticlockwise rotation) and in fig. 4 for single-phase versions, fig. 5 for three-phase versions. Use standard 3-wire cables (2+ground) for single-phase versions, 4-wire cables (3+ground) for three-phase versions.

The reference characteristics (voltage, frequency and input current) are shown on the pump rating plate.

The single-phase pumps have built-in, automatic reset thermo-ampere protection; the three-phase pumps must always be supplied through a magneto-thermal overload cutout set to the rated current.

For ambient temperatures of 40 to 45°C, supply cables with temperature characteristics of at least 95°C and minimum wire gauge of 1.5 mm² must be used.

Check the direction of rotation (three-phase models only)

Clockwise rotation when looking at pump from the motor side.

Check by looking at the fan or by observing the pump's performance.

The correct direction of rotation is the one that generates the highest Q/H performance. In the event of incorrect rotation, switch two supply wires.

6. PRIMING (Fig. 3)

Fill the pump body and suction pipe through the fill plug, bleeding off all the air. For the SP-BG models, self-priming without the foot valve may require up to 3-4 minutes.

We therefore recommend that you always use a foot valve.

7. MAINTENANCE

The pump should be serviced by qualified personnel only, after having been disconnected from the power mains. No routine maintenance is required.

I 8. ISTRUZIONI DI SICUREZZA

FIG. 6 Attenzione ai limiti d'impiego (par.3). Un uso improprio può provocare danni alla pompa, alle cose e alle persone.

FIG. 7 La pompa non è adatta a pompare liquidi infiammabili o pericolosi.

FIG. 8 Accertarsi che la tensione di targa e quella di rete siano compatibili.

FIG. 9 Fare eseguire i collegamenti alla rete e la messa a terra da personale qualificato (elettricista autorizzato) in conformità alle regole nazionali d'installazione.

FIG. 10 Collegarsi alla rete tramite un interruttore onnipolare con distanza dei contatti di almeno 3 mm. Quale protezione supplementare dalle scosse elettriche letali installare un interruttore differenziale ad alta sensibilità (0.03 A).

FIG. 11 Impedire l'accesso alla pompa ai non addetti.

FIG. 12 Togliere tensione all'elettropompa o staccare la spina dalla presa, per i modelli con spina, prima di ogni operazione di manutenzione o pulizia o spostamento. La sostituzione del cavo di alimentazione, se danneggiato, va eseguita da personale qualificato, in modo da prevenire ogni rischio.

FIG. 13 Impiegare la pompa entro i limiti dei dati di targa.

FIG. 14 Non far funzionare la pompa a bocca chiusa.

FIG. 15 Attenzione ai rischi derivanti dalle perdite accidentali.

FIG. 16 Proteggete l'elettropompa dalle intemperie.

FIG. 17 Attenzione alla formazione di ghiaccio.

FIG. 18 Garantire l'autoventilazione del motore.

Attenzione:

Il motore può raggiungere una temperatura di 70° C.

9. RICERCA GUASTI

LA POMPA NON PARTE: • Verificare che vi sia tensione e il collegamento alla rete. Se scattato, riarmare il salvavita o l'interruttore automatico. • Intervenuta la protezione termo-amprometrica incorporata nelle versioni monofase; attendere che si riarmi a raffreddamento avvenuto.

IL MOTORE PARTE MA LA POMPA NON EROGA: • La pompa aspira aria: verificare il livello del liquido, la tenuta della tubazione di aspirazione ed eventuali anomalie della valvola di fondo.

LA POMPA EROGA UNA PORTATA RIDOTTA: • Verificare che non vi siano strozzature e il senso di rotazione nei modelli trifase.

LA POMPA SI FERMA OCCASIONALMENTE: • Intervento protezione termo-amprometrica (versione monofase) o del relè termico per eccessivo assorbimento di corrente: rivolgersi a un Servizio Assistenza Autorizzato.

10. RUMOROSITÀ

	Press. acustica dB(A)
PSA-BG-BGM GARDEN-CEA-CA-HM-LQ (50-60 Hz)	<70
P16 - P21 - P30 - P40 (50 Hz)	<70
P16 - P21 - P30 - P40 (60 Hz)	73±2
P60 - P70 - SP (50 Hz)	72±2
P60 - P70 - SP (60 Hz)	77±2

11. DICHIARAZIONE DI CONFORMITÀ

PRODOTTI: P-PSA-BG-BGM GARDEN-SP-CEA-CA-HM-LQ
Fabbricato da LOWARA – Montecchio Maggiore (VI) – Italy

I prodotti su elencati sono conformi alle seguenti Direttive:
Macchine 98/37/CEE, norma EN 292
Bassa Tensione 73/23/CEE e relative integrazioni, norme EN 60335-1 ed EN 60335-2-41

Compatibilità Elettromagnetica 89/336/CEE e relative integrazioni, norma EN 50081-1 e -2

GB 8. SAFETY INSTRUCTIONS

FIG. 6 Pay attention to the working limits (par. 3). Improper use may damage the pump and other property, and injure people.

FIG. 7 The pump is not suitable for use with flammable or dangerous liquids.

FIG. 8 Make sure that the rated voltage and the mains voltage are compatible.

FIG. 9 The connections to the mains and grounding must be executed by qualified personnel (authorised electrician) in compliance with local installation standards.

FIG. 10 Connect to the power mains using a multi-pole power switch with a switch- contact gap of at least 3 mm. As additional protection from lethal electrical shock, install a high-sensitivity differential switch (0.03 A).

FIG. 11 Make sure that unauthorized people do not have access to the pump.

FIG. 12 Disconnect the power supply to the electric pump or unplug the machine before carrying out any maintenance, cleaning or handling operations. If the power cord is damaged it must be replaced by qualified personnel to ensure against hazards.

FIG. 13 Use the pump only within the limits specified on the rating plate.

FIG. 14 Do not run the pump with the port closed.

FIG. 15 Be alert to hazardous situations caused by accidental power failure.

FIG. 16 Protect the pump from the weather.

FIG. 17 Caution! Avoid icing.

FIG. 18 Make sure the motor is properly ventilated.

Warning: the motor can reach a temperature of 70°C.

9. TROUBLESHOOTING

THE PUMP DOES NOT START: • Check the power supply. Reset the ground fault interrupter or circuit breaker if it has triggered. • The thermo-amprometric protection incorporated in the single-phase versions may have activated: it will reset automatically once the motor has cooled.

THE MOTOR STARTS BUT THE PUMP DOES NOT DELIVER: The pump is sucking in air: check the liquid level, the tightness of the suction pipe and the operation of the foot valve.

THE PUMP'S DELIVERY IS REDUCED: • Check for throttling and direction of rotation in three-phase models.

THE PUMP STOPS OCCASIONALLY: • Triggering of thermo-amprometric protection (single-phase version) or of temperature relay due to excessive current input: contact an Authorized Service Centre.

10. NOISE

	Acoustic pressure dB(A)
PSA-BG-BGM GARDEN-CEA-CA-HM-LQ (50-60 Hz)	<70
P16 - P21 - P30 - P40 (50 Hz)	<70
P16 - P21 - P30 - P40 (60 Hz)	73±2
P60 - P70 - SP (50 Hz)	72±2
P60 - P70 - SP (60 Hz)	77±2

11. DECLARATION OF CONFORMITY

PRODUCTS: P-PSA-BG-BGM GARDEN-SP-CEA-CA-HM-LQ
Manufactured by LOWARA – Montecchio Maggiore (VI) – Italy

The products listed above comply with the following Directives:
Machine Directive 98/37/EEC, EN standard 292
Low Voltage Directive 73/23/EEC and related supplements, EN standards 60335-1 and 60335-2-41.

Electromagnetic Compatibility Directive 89/336/EEC and related supplements, EN standard 50081-1 and -2.

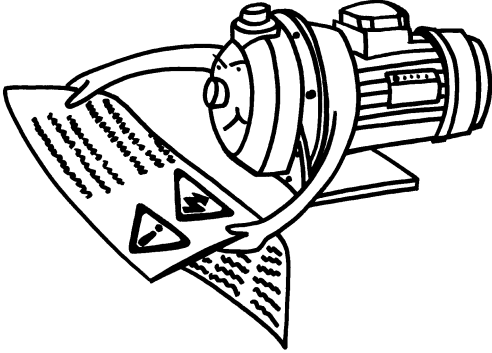

6

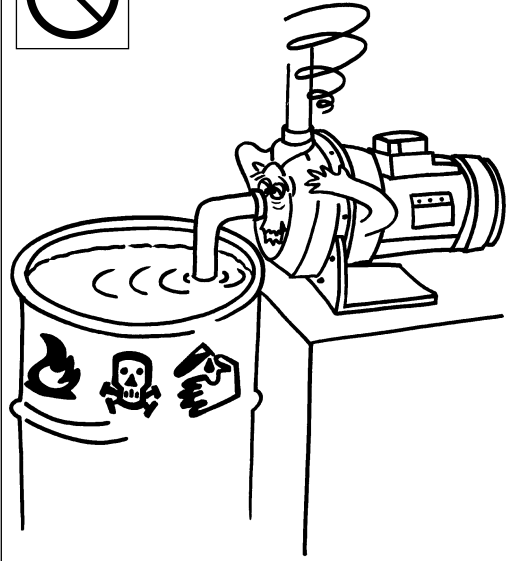

7

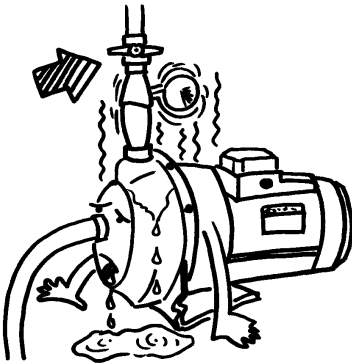

14

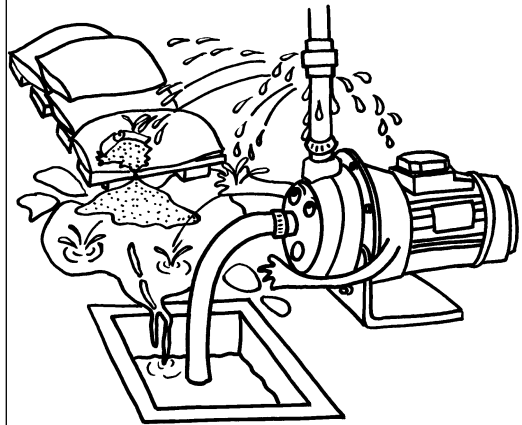

15



230V



50HZ

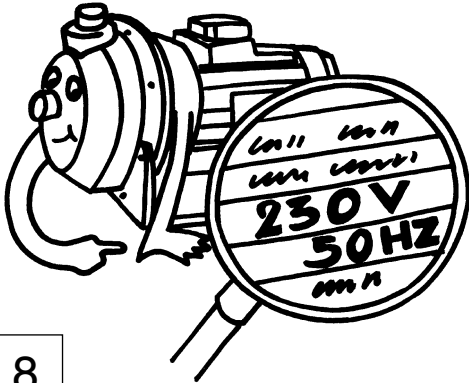

8

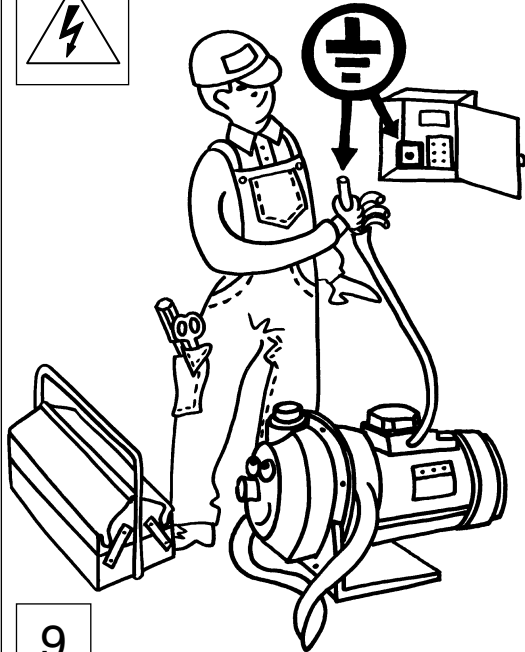

9

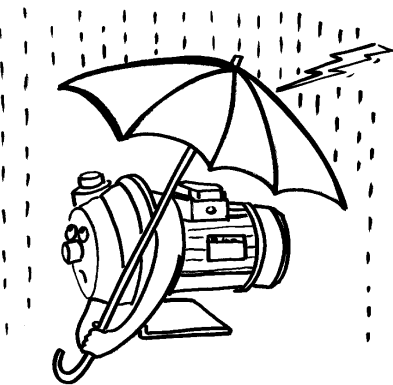

16

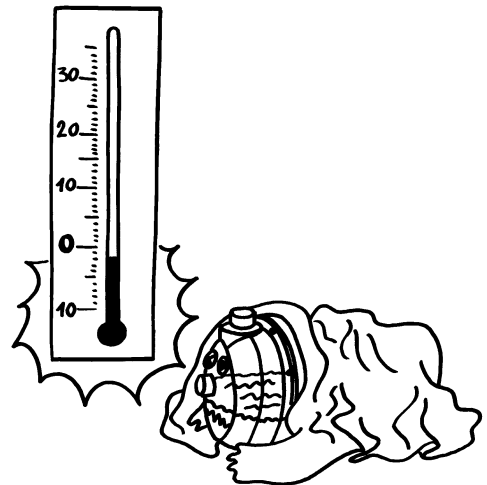

17

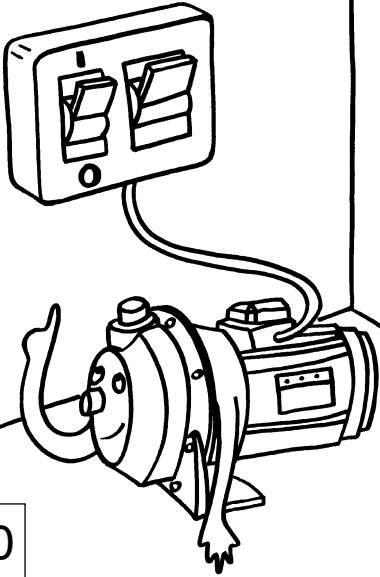

10

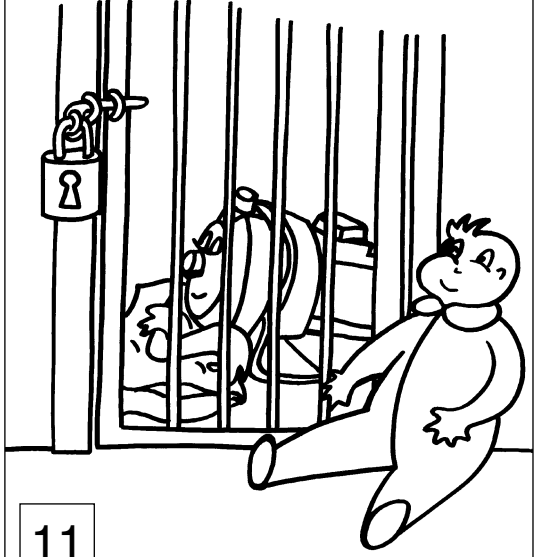

11

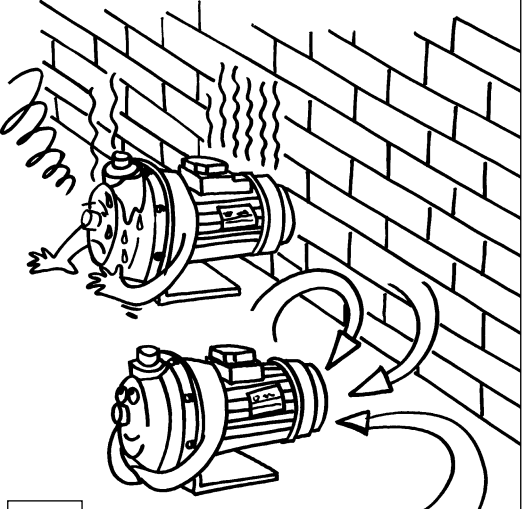

18

*	**	***
13		4HMS36T/A
15		2HMS36T/A
16	CEA370/1/A	
17	CEA210/2/A	CEA2106/0/A-3706/0/A
19	4HMS3T/A	
20	2HMS3T/A, CEA370/2/A	CEA3706/0/A
21	CEA210/3/A	CEA2106/1/A
22	CEA70/3/A-120/3/A	
23		2HM36T/A, 4HM46T/A, CEA3706/1/A
24	2HM3T/A, 4HM4T/A, CEA370/3/A	CEA1206/1/A
26	CEA210/4/A	CEA2106/2/A
27		4HMS56T/A
28	4HMS4T/A	CEA1206/2/A
29	CEA210/5/A	
30	2HMS4RT/A, CEA370/5/A	2HMS46T/A, CEA2106/3/A
31	CEA70/5/A	
32	CEA80/5/A-120/5/A	CEA706/3/A
33		CEA1206/3/A
35		2HM46T/A, 4HM56T/A
36	BG3/A, BGM3/A GARDEN, 2HM4T/A, 4HM5T/A	
37	4HMS5T/A	P16/A
39		CEA706/4/A
40	2HMS4T/A	4HMS96T/A, CEA1206/4/A
41	BG5/A, BGM5/A GARDEN	BG56/A



380v3~



230v1~

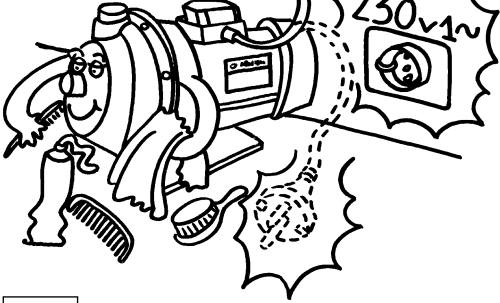

12

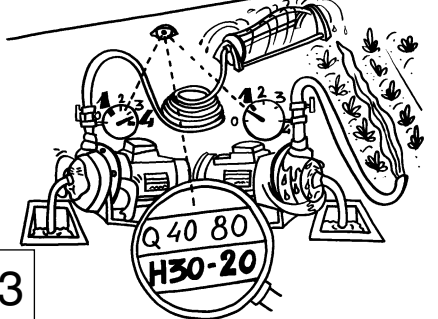
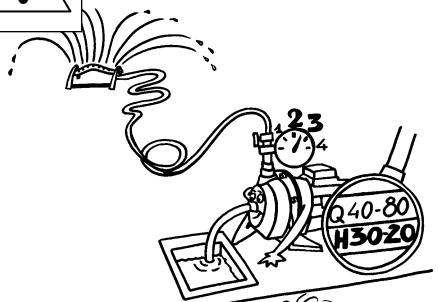

13

*	**	***
43	P16/A, PAB15, CA70/33/A-120/33/A-200/33/A	
45	SP5T/A	CEA706/5/A
46	BG7/A, BGM7/A GARDEN, 4HMS7T/A	2HM56T/A, 4HM76T/A, 2HMS76T/A, SP56T/A
47	2HM5T/A, CA70/34/A	BG76/A, P21/A
48	P21/A, 4HM7T/A	
50	BG9/A, BGM9/A GARDEN, 2HMS7T/A	P30/A
52	CA200/35/A	
53	BG11/A, BGM11/A GARDEN, CA120/35/A	BG116/A
54	SP7T/A	
55	CA70/45/A	P40/A
56	P30/B	
58		2HM76T/A, 4HM96T/A
59	2HM7T/A	
60	4HM9T/A	
61	CA200/55/A	2HMS96T/A
62	CA120/55/A	CA706/33/A-2006/33/A
63	P40/B	CA1206/33/A
75		P60/A
77	P60/A	
89		P70/A
93	PSA70/A	
94		PSA706/A
102	P70/A	

- I** * = Hmax(m) ** = Tipo pompa (50 Hz) *** = Tipo pompa (60 Hz)
- GB** * = Hmax(m) ** = Type of pump (50 Hz) *** = Type of pump (60 Hz)
- F** * = Hmax(m) ** = Type pompe (50 Hz) *** = Type pompe (60 Hz)
- D** * = Hmax(m) ** = Pumpentyp (50 Hz) *** = Pumpentyp (60 Hz)
- E** * = Hmáx.(m) ** = Tipo bomba (50 Hz) *** = Tipo bomba (60 Hz)
- P** * = Hmax(m) ** = Bomba tipo (50 Hz) *** = Bomba tipo (60 Hz)
- NL** * = Hmax(m) ** = Pomptype (50 Hz) *** = Pomptype (60 Hz)
- DK** H * = Maks. stigeøjde (m) ** = pumpetype (50 Hz) *** = pumpetype (60 Hz)
- S** H Max pumphøjde (m) ** = pumptyp (50 Hz) *** = pumptyp (60 Hz)
- N** H * = Maks. pumpehøjde (m) ** = pumpetype (50 Hz) *** = pumpetype (60 Hz)
- SF** H * = Maks. painekorkeus (m) ** = Pumpun tyypit (50 Hz) *** = Pumpun tyypit (60 Hz)
- GR** * = Hmax(m) ** = Είδος αυτλιας (50 Hz) *** = Είδος αυτλιας (60 Hz)
- TR** * = Hmax(m) ** = Pompa cinsi (50 Hz) *** = Pompa cinsi (60 Hz)
- ε** * = أقصى ارتفاع (م) ** = نموذج مضخة (50 هرتز) *** = نموذج مضخة (60 هرتز)
- R** * = Макс. мошн. (м) ** = Тип насоса (50 Гц) *** = Тип насоса (60 Гц)
- PL** * = Hmax(m) ** = Typ pompy (50 Hz) *** = Typ pompy (60Hz)

it Lowara si riserva il diritto di apportare modifiche senza obbligo di preavviso.
en **Lowara reserves the right to make modifications without prior notice.**
fr Lowara se réserve le droit d'apporter des modifications sans obligation de préavis.
de Änderungen, auch ohne vorherige Ankündigung, sind LOWARA jederzeit vorbehalten.
es Lowara se reserva el derecho de realizar modificaciones sin necesidad de aviso previo.
pt A Lowara reserva-se o direito de proceder a alterações sem aviso prévio.
nl Lowara behoudt zich het recht voor om zonder voorafgaand bericht wijzigingen aan te brengen.
da Lowara forbeholder sig retten til at ændre specifikationerne uden meddelelse herom.
no Lowara forbeholder seg retten til å utføre endringer uten forvarsel.
sv Lowara förbehåller sig rätten att utföra ändringar utan förhandsmeddelande.
fi Lowara pidättää itselleen oikeuden tehdä muutoksia ilman ennakoilmoitusta.
is Lowara áskilur sér rétt til að gera breytingar án fyrirvara.
et Lowara jätab endale õiguse teha muudatusi eelnevalt ette teatamata
lv Lowara patur tiesības veikt izmaiņas bez iepriekšēja brīdinājuma.
pl „Lowara” pasilieka teisę atlikti pakeitimus be išankstinio įspėjimo.
cs Společnost Lowara si vyhrazuje právo na provedení změn bez předcházejícího upozornění.
sk Spoločnosť Lowara si vyhradzuje právo na vykonanie zmien bez predchádzajúceho upozornenia.
hu A Lowara fenntartja magának a jogot előzetes értesítés nélküli módosítások eszközésére.
ro Lowara își rezervă dreptul de a face modificări fără o înștiințare prealabilă.
bg Фирмата Ловара си запазва правото да нанася промени без предупреждение
hr Lowara si pridržuje pravico do vnašanja sprememb brez vsakršnega predhodnega obvestila.
sl Lowara zadržava pravo promjene bez obaveze prethodne najave.
sr Lowara zadržava pravo promene bez obaveze prethodne najave.
el Η Lowara διατηρεί το δικαίωμα να επιφέρει τροποποιήσεις χωρίς προειδοποίηση
tr Lowara şirketi önceden haber vermeksizin deęişiklikler yapma hakkını saklı tutmaktadır
ru Lowara оставляет за собой право вносить изменения без предварительного уведомления.
uk Компанія Lowara залишає за собою право вносити зміни без попередження.

تحفظ شركة لوارا Lowara بحق إجراء تعديلات بدون الالتزام بالتنبية المسبق.

Headquarters

LOWARA S.R.L. UNIPERSONALE

Via Vittorio Lombardi 14

36075 Montecchio Maggiore VI

Italia

Tel. (+39) 0444 707111 - Fax (+39) 0444 492166

e-mail: lowara.mkt@xyleminc.com

web: www.lowara.com

